

ZEUS HYDRATECH LTD
Global Suppliers of Premium Hydraulic Components

Danfoss Sales

T: +44(0)1172 130042. E: sales@zeushydratech.com. W: zeushydratech.com

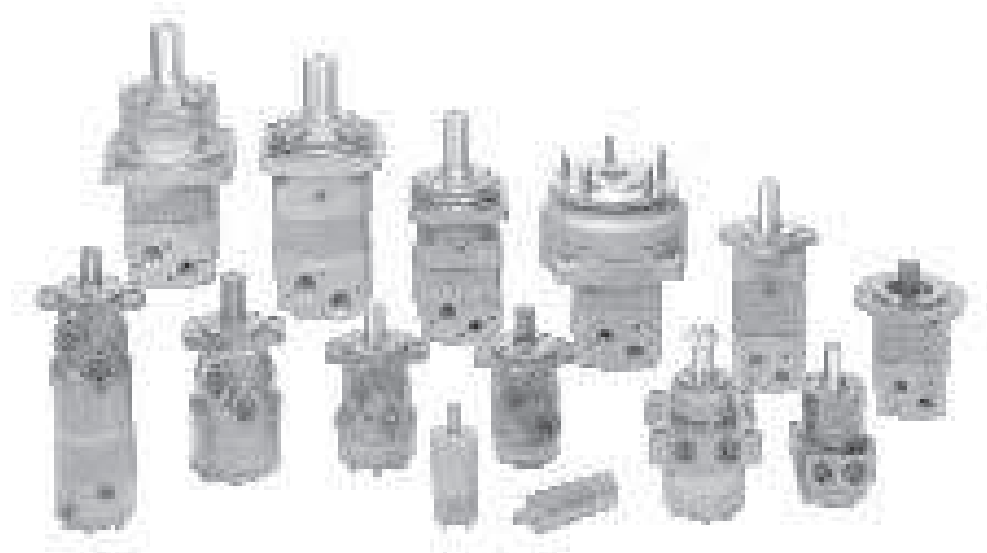

Motorer.TIF

A WIDE RANGE OF HYDRAULIC MOTORS

Sauer-Danfoss is a world leader within production of low speed hydraulic motors with high torque. We can offer more than 1600 different hydraulic motors, categorised in types, variants and sizes (incl. different shaft versions).

The motors vary in size (rated displacement) from 8 cm³ (0.50 in³) to 800 cm³ (48.9 in³) per revolution.

Speeds range up to approx. 2500 min⁻¹ (rpm) for the smallest type and up to approx 600 min⁻¹ (rpm) for the largest type.

Maximum operating torques vary from 13 Nm (115 lbf-in) to 2700 Nm (24.000 lbf-in) (peak) and maximum outputs are from 2,0 kW (2,7 hp) to 70 kW (95 hp).

Characteristic features:

- Smooth running over the entire speed range
- Constant operating torque over a wide speed range
- High starting torque
- High return pressure without the use of drain line (High pressure shaft seal)
- High efficiency
- Long life under extreme operating conditions
- Robust and compact design
- High radial and axial bearing capacity
- For applications in both open and closed loop hydraulic systems
- Suitable for a wide variety of hydraulics fluids

© 2001 Sauer-Danfoss

Sauer-Danfoss can accept no responsibility for possible errors in catalogues, brochures and other printed material. Sauer-Danfoss reserves the right to alter its products without prior notice. This also applies to products already ordered provided that such alterations can be made without subsequent changes being necessary in specifications already agreed. All trademarks in this material are properties of the respective companies. Sauer-Danfoss and the Sauer-Danfoss logotype are trademarks of the Sauer-Danfoss Group. All rights reserved.

Frontpage: Drawing 151-1837, F73375.TIF, F73337.TIF, F73338.TIF, F66104.TIF, F71934.eps

OMP, OMR, OMH and OMEW Hydraulic Motor A wide range of hydraulic motors

The programme is characterised by technical features appealing to a large number of applications and a part of the programme is characterised by motors that can be adapted to a given application. Adaptions comprise the following variants among others:

- Motors with corrosion resistant parts
- Wheel motors with recessed mounting flange
- OMP, OMR- motors with needle bearing
- OMR motor in low leakage version
- OMR motors in a super low leakage version
- Short motors without bearings
- Ultra short motors
- Motors with integrated positive holding brake
- Motors with integrated negative holding brake
- Motors with integrated flushing valve
- Motors with speed sensor
- Motors with tacho connection
- All motors are available with black finish paint

Planetary gears

Sauer - Danfoss complements the motor range with a complete programme of planetary gears adapted to suit. The combination of motors and gears makes it possible to obtain smooth running at fractional speeds and with torques up to 650.000 Nm (5.800.000 lbf-in).

The Sauer–Danfoss LSHT motors are used in the following application areas:

- Construction equipment
- Agricultural equipment
- Material handling & Lifting equipment
- Forestry equipment
- Lawn and turf equipment
- Special purpose
- Machine tools and stationary equipment
- Marine equipment

SURVEY OF LITERATURE WITH TECHNICAL DATA ON DANFOSS HYDRAULIC MOTORS

Detailed data on all Sauer-Danfoss motors can be found in our motor catalogue, which is divided into 5 individual subcatalogues:

- General information on Sauer-Danfoss hydraulic motors: function, use, selection of hydraulic motor, hydraulic systems, etc.
- Technical data on small motors: OML and OMM
- Technical data on medium sized motors: OMP, OMR, OMH and OMEW
- Technical data on medium sized motors: DH and DS
- Technical data on large motors: OMS, OMT and OMV
- Technical data on large motors: TMT

A general survey brochure on Sauer-Danfoss hydraulic motors gives a quick motor reference based on power, torque, speed and capabilities.

CONTENTS

	Page
OMP, OMR, OMH and OMEW	6
Speed, torque and output	6
OMP	8
Version.....	8
Code number	9
Technical data	10-26
Technical data (e.g. speed, torque, pressure etc.)	10-12
Max. permissible shaft seal pressure.....	13
Pressure drop in motor, oil flow in drain line, direction of shaft rotation	14
Permissible shaft loads	15-17
Function diagrams	18-23
Shaft version	24-25
Port thread versions.....	26
Dimensions.....	27-35
OMR	36
Version.....	36
Code number	37
Technical data	38-54
Technical data (e.g. speed, torque, pressure etc.)	38-40
Max. permissible shaft seal pressure.....	41
Pressure drop in motor, oil flow in drain line, direction of shaft rotation	42
Permissible shaft loads	43-44
Function diagrams	45-49
Shaft version	50-53
Port thread versions.....	54
Dimensions	55
Dimensions	55-65
OMH	66
Version.....	66
Code number	67
Technical data	68-80
Technical data (e.g. speed, torque, pressure etc.)	68-70
Max. permissible shaft seal pressure.....	71
Pressure drop in motor, oil flow in drain line, direction of shaft rotation	72
Permissible shaft loads	73
Function diagrams	74-76
Shaft version	77-79
Port thread versions.....	80
Dimensions	81
Dimensions	81-82

CONTENTS

	Page
OMEW	84
Version.....	84
Code number	85
Technical data	86-94
Technical data (e.g. speed, torque, pressure etc.)	86
Max. permissible shaft seal pressure.....	87
Pressure drop in motor, direction of shaft rotation	88
Permissible shaft loads	89
Function diagrams	90-92
Shaft version.....	93
Port thread versions.....	94
Dimensions	95
Dimensions	95-96
Weight of motors	97-99

SPEED, TORQUE AND OUTPUT

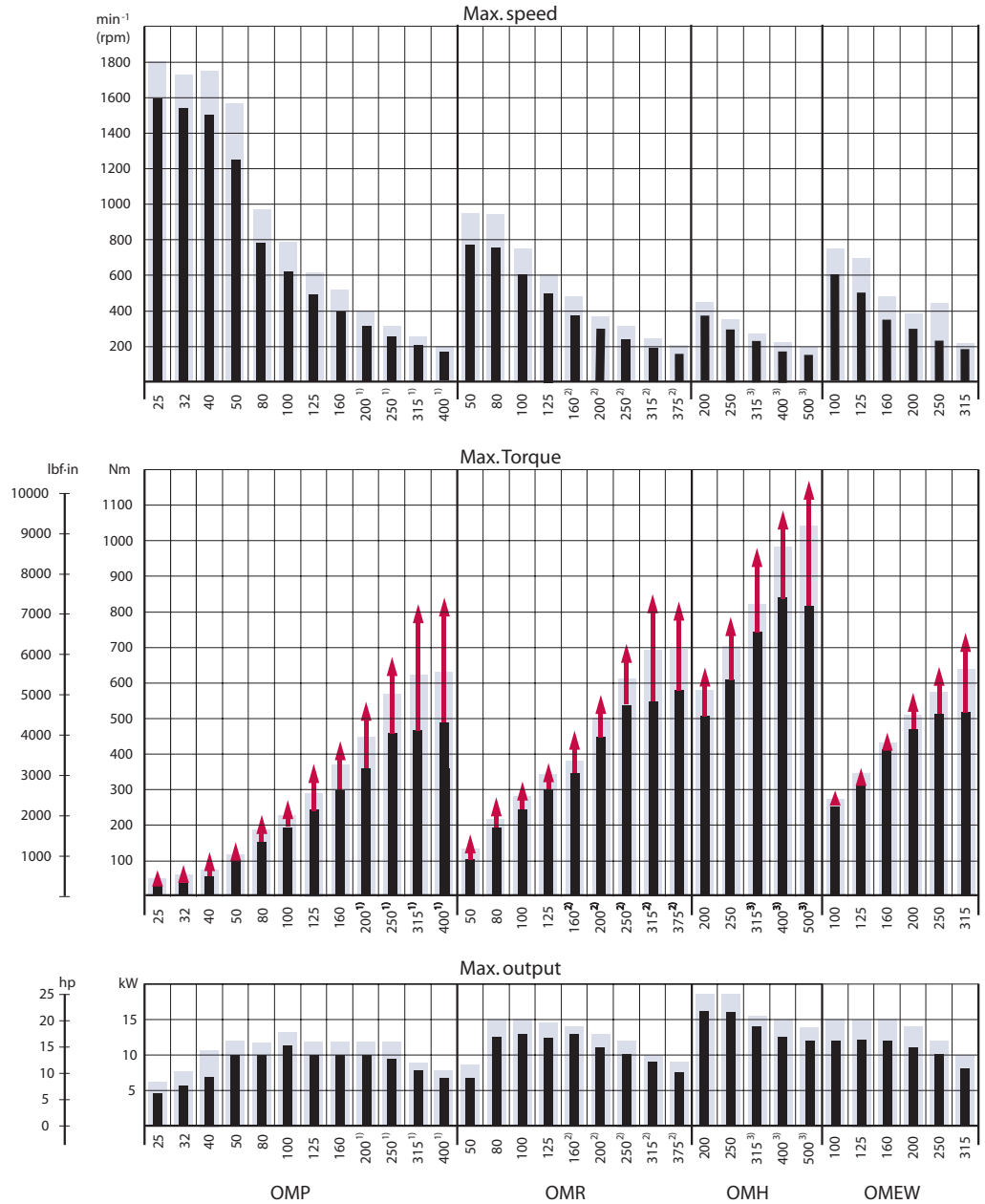

Peak values ↑ Intermittend values █ Continuous values █

151-1410.10

- 1) $\varnothing 1\frac{1}{4}$ in shaft
- 2) $\varnothing 1\frac{1}{4}$ in or $1\frac{1}{4}$ in tapered shaft
- 3) $1\frac{1}{4}$ in splined shaft



OMP, OMR, OMH and OMEW Hydraulic Motor Data survey

SPEED, TORQUE AND OUTPUT

The bar diagrams above are useful for a quick selection of relevant motor size for the application. The final motor size can be determined by using the function diagram for each motor size.

- OMP and OMPW can be found on pages 18 - 23
- OMR and OMRW can be found on pages 45 - 49
- OMH can be found on pages 74 - 76
- OMEW can be found on pages 90 - 92

The function diagrams are based on actual tests on a representative number of motors from our production. The diagrams apply to a return pressure between 5 and 10 bar (75 and 150 psi) when using mineral based hydraulic oil with a viscosity of 35 mm²/s (165 SUS) and a temperature of 50°C (120°F). For further explanation concerning how to read and use the function diagrams, please consult the paragraph "Selection of motor size" in the technical information "General" DHMH.PK.100.G2.02 520L0232.

VERSIONS

Mounting flange	Shaft	Port size	European version	US version	Side port version	End port version	Flange port version	Standard shaft seal	High pressure shaft seal	Drain connection	Check valve	Specials	Main type designation
2 hole oval flange (A2-flange)	Cyl. 25 mm	G 1/2	X		X				X	No	No		OMP
		G 1/2	X		X				X	Yes	No		OMP
		G 1/2	X		X			X		Yes	Yes	A	OMP C
		G 1/2	X			X		X		Yes	Yes		OMP
	Cyl. 1 in	G 1/2	X		X				X	No	No		OMP
		G 1/2	X		X				X	Yes	No		OMP
		7/8 - 14 UNF		X	X			X		Yes	Yes		OMP
	Splined 1 in	G 1/2	X		X				X	No	No		OMP
G 1/2		X		X				X	Yes	No		OMP	
4 hole oval flange (A4 flange)	Cyl. 32 mm	G 1/2	X		X			X		Yes	Yes		OMP
Square flange (C-flange)	Cyl. 25 mm	G 1/2	X			X		X		Yes	Yes		OMP
	Cyl. 1 in	7/8 - 14 UNF		X	X			X		Yes	Yes		OMP
		1/2 - 14 NPTF		X	X			X		Yes	Yes		OMP
Wheel	Cyl. 25 mm	G 1/2	X				X	X		Yes	Yes		OMPW
	Tap. 28.5 mm	G 1/2	X				X	X		Yes	Yes	B	OMPW N

Function diagram – see page : →

Specials:

- A : Corrosion resistant parts
- B : With needle bearings

Features available (options) :

- Free running gerotor
- Low leakage (low speed valve)
- Speed sensor
- Viton shaft seal
- Reverse rotation
- Drain
- Corrosion protected
- Painted
- With needle bearings

CODE NUMBERS

CODE NUMBERS	DISPLACEMENT [cm ³]												Technical data – Page	Dimensions – Page
	25	32	40	50	80	100	125	160	200	250	315	400		
151-	0340	0341	0342	0310	0311	0312	0313	0314	0315	0316	0317	0318	10	27
151-	0640	0641	0642	0610	0611	0612	0613	0614	0615	0616	0617	0618	10	28
151-	-	-	-	1208	1209	1210	1217	1211	1212	1213	1214	1215	10	29
151-	-	-	-	5191	5192	5193	5194	5195	5196	5197	5198	5199	10	30
151-	-	-	-	0300	0301	0302	0303	0304	0305	0306	0307	0308	10	27
151-	-	-	-	0600	0601	0602	0603	0604	0605	0606	0607	0608	10	28
151-	7080	7081	7082	7041	7042	7043	7044 ¹⁾	7045	7046	7047	7048	7049	10	31
151-	-	-	-	0330	0331	0332	0333	0334	0335	0336	0337	0338	11	27
151-	-	-	-	0630	0631	0632	0633	0634	0635	0636	0637	0638	11	28
151-	-	-	-	5001	5002	5003	5004	5005	5006	5007	5008	5009	12	32
151-	-	-	-	5211	5212	5213	5214	5215	5216	5217	5218	5219	10	33
151-	-	-	-	7061	7062	7063	5174	7065	7066	7067	7068	7069	10	34
151-	-	-	-	7021	7022	7023	7024	7025	7026	7027	7028	7029	10	34
151-	-	-	-	7101	7102	7103	7104	7105	7106	7107	7108	7109	10	35
151-	-	-	-	5301	5302	5303	5304	5305	5306	5307	5308	5309	11	35
	18	18	19	19	20	20	21	21	22	22	23	23		

1) Motor is painted black

Ordering

Add the four digit prefix "151-" to the four digit numbers from the chart for complete code number.

Example:

151-0305 for an OMP 200 with A2 flange, cyl. 1 in shaft, port size G 1/2 and high pressure shaft seal.

Note: Orders will not be accepted without the four digit prefix.

TECHNICAL DATA FOR OMP/OMPW WITH 25 MM AND 1 IN CYLINDRICAL SHAFT

Type		OMP	OMP	OMP	OMP	OMP	OMP	OMP	OMP	OMP	OMP	OMP	OMP	
Motor size		25	32	40	50	80	100	125	160	200	250	315	400	
Geometric displacement	cm ³ (in ³)	25.0 (1.53)	32.0 (1.96)	40.0 (2.45)	48.6 (2.97)	77.8 (4.76)	97.3 (5.95)	125.0 (7.65)	155.7 (9.53)	194.6 (11.91)	242.3 (14.83)	306.1 (18.73)	389.2 (23.82)	
Max. speed	min ⁻¹ (rpm)	cont.	1600	1560	1500	1230	770	615	480	385	310	250	195	155
		int. ¹⁾	1800	1720	1750	1540	960	770	600	480	385	310	245	190
Max. torque	Nm (lbf-in)	cont.	33 (290)	43 (380)	52 (460)	93 (820)	150 (1330)	190 (1680)	240 (2120)	300 (2660)	300 (2660)	300 (2660)	300 (2660)	300 (2660)
		int. ¹⁾	47 (420)	61 (540)	74 (660)	120 (1060)	190 (1680)	230 (2040)	290 (2570)	370 (3280)	380 (3360)	410 (3630)	390 (3450)	420 (3720)
		peak ²⁾	67 (590)	86 (760)	107 (950)	140 (1240)	220 (1950)	270 (2390)	370 (3280)	430 (3810)	540 (4780)	550 (4870)	600 (5310)	600 (5310)
Max. output	kW (hp)	cont.	4.5 (6.0)	5.8 (7.8)	7.0 (9.4)	10.0 (13.4)	10.0 (13.4)	11.0 (14.8)	10.0 (13.4)	10.0 (13.4)	8.0 (10.7)	6.0 (8.1)	5.0 (6.7)	4.0 (5.4)
		int. ¹⁾	6.1 (8.2)	7.8 (10.5)	10.6 (14.2)	12.0 (16.1)	12.0 (16.1)	13.0 (17.4)	12.0 (16.1)	12.0 (16.1)	11.0 (14.8)	9.0 (12.1)	7.0 (9.4)	6.0 (8.1)
Max. pressure drop	bar (psi)	cont.	100 (1450)	100 (1450)	100 (1450)	140 (2030)	140 (2030)	140 (2030)	140 (2030)	140 (2030)	115 (1670)	90 (1310)	75 (1090)	60 (870)
		int. ¹⁾	140 (2030)	140 (2030)	140 (2030)	175 (2540)	175 (2540)	175 (2540)	175 (2540)	175 (2540)	150 (2180)	125 (1810)	100 (1450)	80 (1160)
		peak ²⁾	225 (3260)	225 (3260)	225 (3260)	225 (3260)	225 (3260)	225 (3260)	225 (3260)	225 (3260)	225 (3260)	225 (3260)	180 (2610)	160 (2320)
Max. oil flow	l/min (USgal/min)	cont.	40 (10.6)	50 (13.2)	60 (15.9)	60 (15.9)	60 (15.9)	60 (15.9)	60 (15.9)	60 (15.9)	60 (15.9)	60 (15.9)	60 (15.9)	60 (15.9)
		int. ¹⁾	45 (11.9)	55 (14.5)	70 (18.5)	75 (19.8)	75 (19.8)	75 (19.8)	75 (19.8)	75 (19.8)	75 (19.8)	75 (19.8)	75 (19.8)	75 (19.8)
Max. starting pressure with unloaded shaft	bar (psi)	10 (145)	10 (145)	10 (145)	10 (145)	10 (145)	10 (145)	9 (130)	7 (100)	5 (75)	5 (75)	5 (75)	5 (75)	
Min. starting torque	at max. press. drop cont.	30 (270)	40 (350)	45 (400)	80 (710)	135 (1200)	170 (1510)	210 (1860)	280 (2480)	270 (2390)	280 (2480)	280 (2480)	280 (2480)	
	at max. press. drop int. ¹⁾	40 (350)	55 (490)	63 (560)	100 (890)	170 (1510)	210 (1860)	270 (2390)	350 (3100)	360 (3190)	390 (3450)	370 (3280)	400 (3540)	
Min. speed ³⁾	min ⁻¹ (rpm)	20	15	10	10	10	9	9	8	7	5	5	5	

¹⁾ Intermittent operation: the permissible values may occur for max. 10% of every minute.

²⁾ Peak load: the permissible values may occur for max. 1% of every minute.

³⁾ Operation at lower speeds may be slightly less smooth.

TECHNICAL DATA FOR OMP/OMPW WITH 1 IN SPLINED AND 28,5 MM TAPERED SHAFT

Type		OMP	OMP	OMP	OMP	OMP	OMP	OMP	OMP	OMP	
Motor size		50	80	100	125	160	200	250	315	400	
Geometric displacement	cm ³ (in ³)	48.6 (2.97)	77.8 (4.76)	97.3 (5.95)	125.0 (7.65)	155.7 (9.53)	194.6 (11.91)	242.3 (14.83)	306.1 (18.73)	389.2 (23.82)	
Max. speed	min ⁻¹ (rpm)	cont.	1230	770	615	480	385	310	250	195	155
		int. ¹⁾	1540	960	770	600	480	385	310	245	190
Max. torque	Nm (lbf-in)	cont.	93 (820)	150 (1330)	190 (1680)	240 (2120)	300 (2660)	360 (3190)	360 (3190)	360 (3190)	360 (3190)
		int. ¹⁾	120 (1060)	190 (1680)	230 (2040)	290 (2570)	370 (3280)	450 (3980)	460 (4070)	470 (4160)	460 (4070)
		peak ²⁾	140 (1240)	220 (1950)	270 (2390)	370 (3280)	430 (3810)	540 (4780)	550 (4870)	540 (4780)	560 (4960)
Max. output	kW (hp)	cont.	10.0 (13.4)	10.0 (13.4)	11.0 (14.8)	10.0 (13.4)	10.0 (13.4)	10.0 (13.4)	8.0 (10.7)	6.0 (8.0)	5.0 (6.7)
		int. ¹⁾	12.0 (16.1)	12.0 (16.1)	13.0 (17.4)	12.0 (16.1)	12.0 (16.1)	12.0 (16.1)	10.5 (14.1)	7.5 (10.1)	6.0 (8.0)
Max. pressure drop	bar (psi)	cont.	140 (2030)	140 (2030)	140 (2030)	140 (2030)	140 (2030)	140 (2030)	105 (1520)	90 (1310)	70 (1020)
		int. ¹⁾	175 (2540)	175 (2540)	175 (2540)	175 (2540)	175 (2540)	175 (2540)	140 (2030)	120 (1740)	90 (1310)
		peak ²⁾	225 (3260)	225 (3260)	225 (3260)	225 (3260)	225 (3260)	225 (3260)	180 (2610)	160 (2320)	130 (1890)
Max. oil flow	l/min (USgal/min)	cont.	60 (15.9)	60 (15.9)	60 (15.9)	60 (15.9)	60 (15.9)	60 (15.9)	60 (15.9)	60 (15.9)	60 (15.9)
		int. ¹⁾	75 (19.8)	75 (19.8)	75 (19.8)	75 (19.8)	75 (19.8)	75 (19.8)	75 (19.8)	75 (19.8)	75 (19.8)
Max. starting pressure with unloaded shaft	bar (psi)	10 (145)	10 (145)	10 (145)	9 (130)	7 (100)	5 (75)	5 (75)	5 (75)	5 (75)	
Min. starting torque	at max. press. drop cont.	80 (710)	135 (1200)	170 (1510)	210 (1860)	280 (2480)	340 (3010)	330 (2920)	340 (3010)	345 (3050)	
	at max. press. drop int. ¹⁾	100 (890)	170 (1510)	210 (1860)	270 (2390)	350 (3100)	420 (3720)	440 (3890)	450 (3980)	425 (3760)	
Min. speed ³⁾	min ⁻¹ (rpm)	10	10	9	9	8	7	5	5	5	

¹⁾ Intermittent operation: the permissible values may occur for max. 10% of every minute.

²⁾ Peak load: the permissible values may occur for max. 1% of every minute.

³⁾ Operation at lower speeds may be slightly less smooth.

TECHNICAL DATA FOR OMP/OMPW WITH 32 MM CYLINDRICAL SHAFT

Type		OMP	OMP	OMP	OMP	OMP	OMP	OMP	OMP	OMP	
Motor size		50	80	100	125	160	200	250	315	400	
Geometric displacement	cm ³ (in ³)	48.6 (2.97)	77.8 (4.76)	97.3 (5.95)	125.0 (7.65)	155.7 (9.53)	194.6 (11.91)	242.3 (14.83)	306.1 (18.73)	389.2 (23.82)	
Max. speed	min ⁻¹ (rpm)	cont.	1230	770	615	480	385	310	250	195	155
		int. ¹⁾	1540	960	770	600	480	385	310	245	190
Max. torque	Nm (lbf-in)	cont.	93 (820)	150 (1330)	190 (1680)	240 (2120)	300 (2660)	360 (3190)	460 (4070)	470 (4160)	490 (4340)
		int. ¹⁾	120 (1060)	190 (1680)	230 (2040)	290 (2570)	370 (3280)	450 (3980)	570 (5050)	620 (5490)	630 (5580)
		peak ²⁾	140 (1240)	220 (1950)	270 (2390)	370 (3280)	430 (3810)	540 (4780)	670 (5930)	820 (7260)	840 (7440)
Max. output	kW (hp)	cont.	10.0 (13.4)	10.0 (13.4)	11.0 (14.8)	10.0 (13.4)	10.0 (13.4)	10.0 (13.4)	9.5 (12.7)	7.5 (10.1)	6.5 (8.7)
		int. ¹⁾	12.0 (16.1)	12.0 (16.1)	13.0 (17.4)	12.0 (16.1)	12.0 (16.1)	12.0 (16.1)	12.0 (16.1)	9.0 (12.1)	7.5 (10.1)
Max. pressure drop	bar (psi)	cont.	140 (2030)	140 (2030)	140 (2030)	140 (2030)	140 (2030)	140 (2030)	140 (2030)	120 (1741)	95 (1380)
		int. ¹⁾	175 (2540)	175 (2540)	175 (2540)	175 (2540)	175 (2540)	175 (2540)	175 (2540)	160 (2320)	125 (1810)
		peak ²⁾	225 (3260)	225 (3260)	225 (3260)	225 (3260)	225 (3260)	225 (3260)	225 (3260)	225 (3260)	180 (2610)
Max. oil flow	l/min (USgal/min)	cont.	60 (15.9)	60 (15.9)	60 (15.9)	60 (15.9)	60 (15.9)	60 (15.9)	60 (15.9)	60 (15.9)	60 (15.9)
		int. ¹⁾	75 (19.8)	75 (19.8)	75 (19.8)	75 (19.8)	75 (19.8)	75 (19.8)	75 (19.8)	75 (19.8)	75 (19.8)
Max. starting pressure with unloaded shaft	bar (psi)	10 (145)	10 (145)	10 (145)	9 (130)	7 (100)	5 (75)	5 (75)	5 (75)	5 (75)	
Min. starting torque	at max. press. drop cont.	80 (710)	135 (1200)	170 (1510)	210 (1860)	280 (2480)	340 (3010)	420 (3720)	460 (4070)	460 (4070)	
	at max. press. drop int. ¹⁾	100 (890)	170 (1510)	210 (1860)	270 (2390)	350 (3100)	420 (3720)	530 (4690)	600 (5310)	600 (5310)	
	Nm (lbf-in)										
Min. speed ³⁾	min ⁻¹ (rpm)	10	10	9	9	8	7	5	5	5	

Type		Max. inlet pressure	Max. return pressure with drain line
OMP 25 - 400	bar (psi) cont.	175 (2540)	175 (2540)
	bar (psi) int. ¹⁾	200 (2900)	200 (2900)
	bar (psi) peak ²⁾	225 (3260)	225 (3260)

¹⁾ Intermittent operation: the permissible values may occur for max. 10% of every minute.

²⁾ Peak load: the permissible values may occur for max. 1% of every minute.

³⁾ Operation at lower speeds may be slightly less smooth.

OMP WITH HIGH PRESSURE SHAFT SEAL (HPS)

OMP with HPS and without drain connection:
The shaft seal pressure equals the average of input pressure and return pressure.

$$P_{\text{seal}} = \frac{P_{\text{in}} + P_{\text{return}}}{2}$$

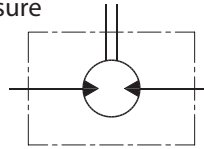

151-1743.10

OMP with HPS and drain connection:
The shaft seal pressure equals the pressure in the drain line.

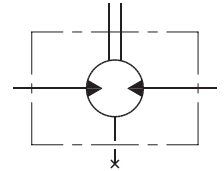

151-1855.10

Max. permissible shaft seal pressure

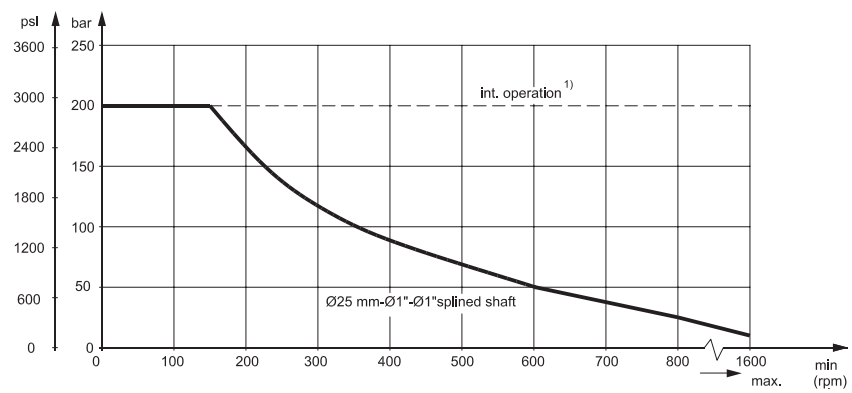

151-1745.10

OMP WITH STANDARD SHAFT SEAL

OMP with standard shaft seal, check valves and without use of drain connection:
The pressure on the shaft seal never exceeds the pressure in the return line

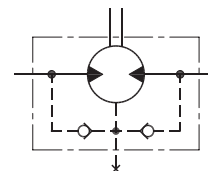

151-320.10

OMP with standard shaft seal, check valves and with drain connection:
The shaft seal pressure equals the pressure on the drain line.

Max. return pressure without drain line or max. pressure in the drain line

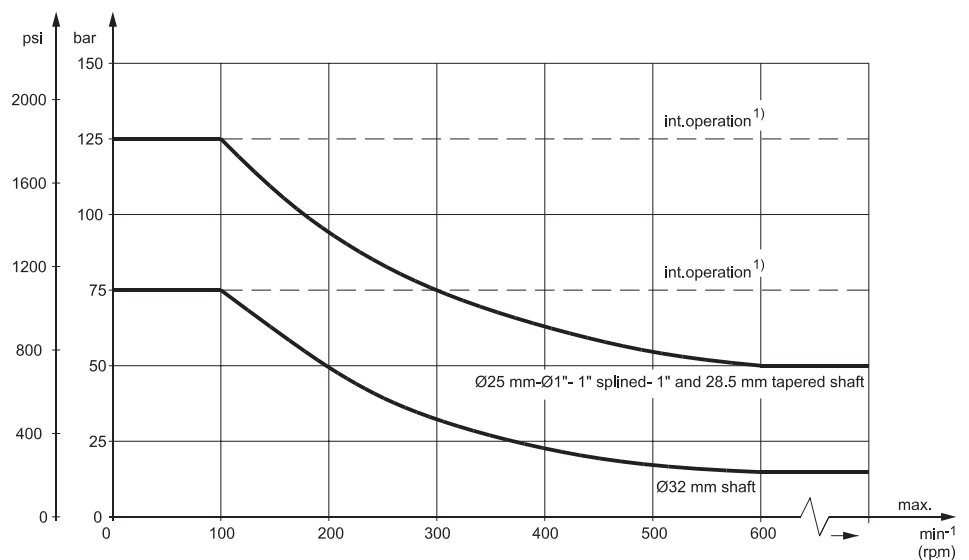

151-1563.10

¹⁾ Intermittent operation: the permissible values may occur for max. 10% of every minute.

PRESSURE DROP IN MOTOR

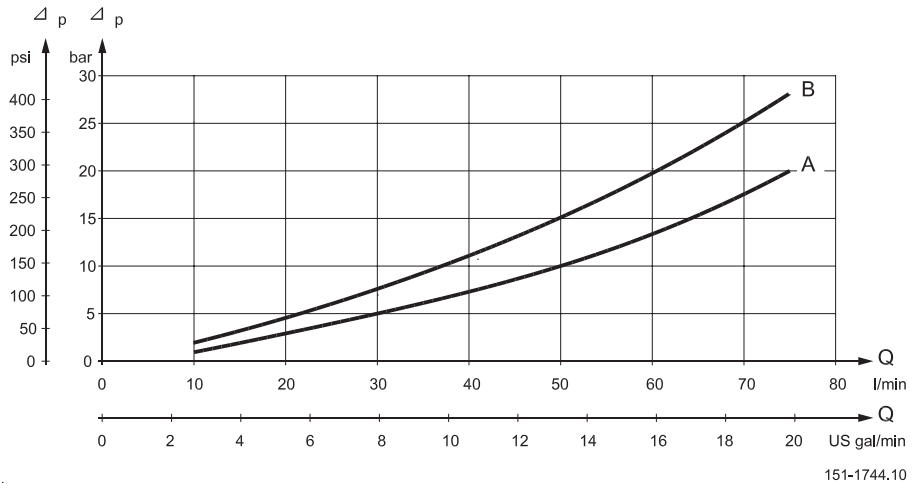

The curve applies to an unloaded motor shaft and an oil viscosity of 35 mm²/s (165 SUS)

A: OMP 50 - 400
B: OMP 25 - 40 / OMPW

OIL FLOW IN DRAIN LINE

The table shows the max. oil flow in the drain line at a return pressure less than 5-10 bar (75-150 psi).

Pressure drop bar (psi)	Viscosity mm ² /s (SUS)	Oil flow in drain line l/min (US gal/min)
100 (1450)	20 (100)	2.5 (0.66)
	35 (165)	1.8 (0.78)
140 (2030)	20 (100)	3.5 (0.93)
	35 (165)	2.8 (0.74)

DIRECTION OF SHAFT ROTATION

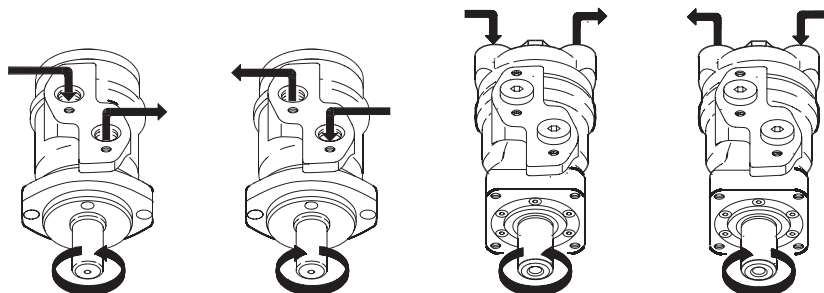

151-1836.10

PERMISSIBLE SHAFT LOADS FOR OMP

The permissible radial shaft load (P_R) depends on

- speed (n)
- distance (l) from the point of load to the mounting flange
- mounting flange version
- shaft version

Mounting flange	4-hole oval flange** 2-hole oval flange (European version)	4-hole oval flange	Square flange** 2-hole oval flange (US version)
Shaft version	25 mm cylindrical shaft 1 in cylindrical shaft 1 in splined shaft	32 mm cylindrical shaft	25 mm cylindrical shaft
Permissible shaft load (P_R) l in mm	$\frac{800}{n} \times \frac{250000}{95+l} \text{ N}^*$	$\frac{800}{n} \times \frac{187500}{95+l} \text{ N}^*$	$\frac{800}{n} \times \frac{250000}{101+l} \text{ N}^*$
Permissible shaft load (P_R) l in inch	$\frac{800}{n} \times \frac{2215}{3.74+l} \text{ lbf}^*$	$\frac{800}{n} \times \frac{1660}{3.74+l} \text{ lbf}^*$	$\frac{800}{n} \times \frac{2215}{3.98+l} \text{ lbf}^*$

* $n \geq 200 \text{ min}^{-1} \text{ (rpm)}$; $l \leq 55 \text{ mm (2.2 in)}$
 $n < 200 \text{ min}^{-1} \text{ (rpm)}$; $\Rightarrow P_{Rmax} = 8000 \text{ N (1800 lbf)}$

** For both European and US version

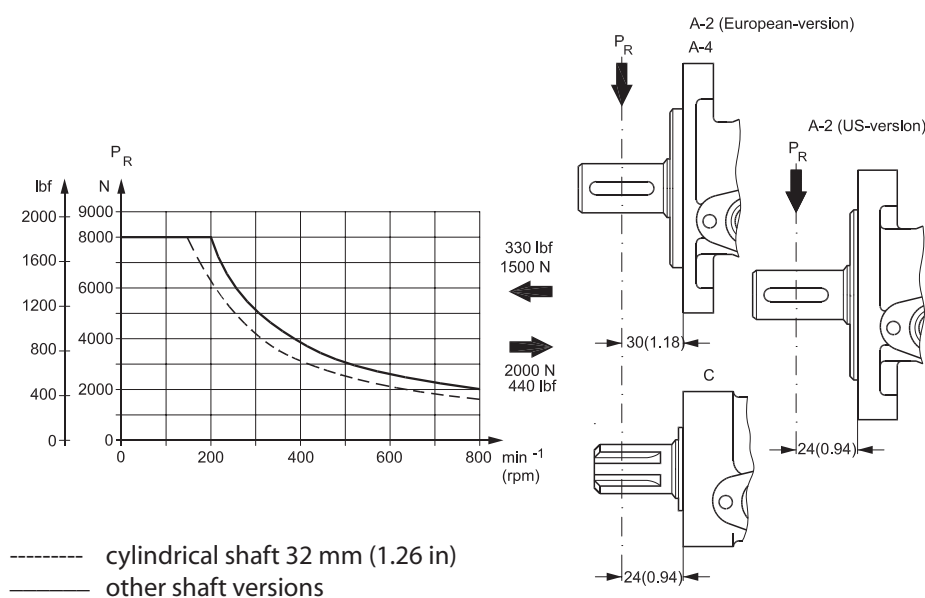

151-1203.10

The curve shows the relation between P_R and n

- when $l = 30 \text{ mm (1.18 in)}$ for motors with oval mounting flange
- when $l = 24 \text{ mm (0.94 in)}$ for motors with square mounting flange

For applications with special performance requirements we recommend OMP with the output shaft running in needle bearings.

**PERMISSIBLE SHAFT
LOAD FOR OMPW WITH
SLIDE BEARINGS**

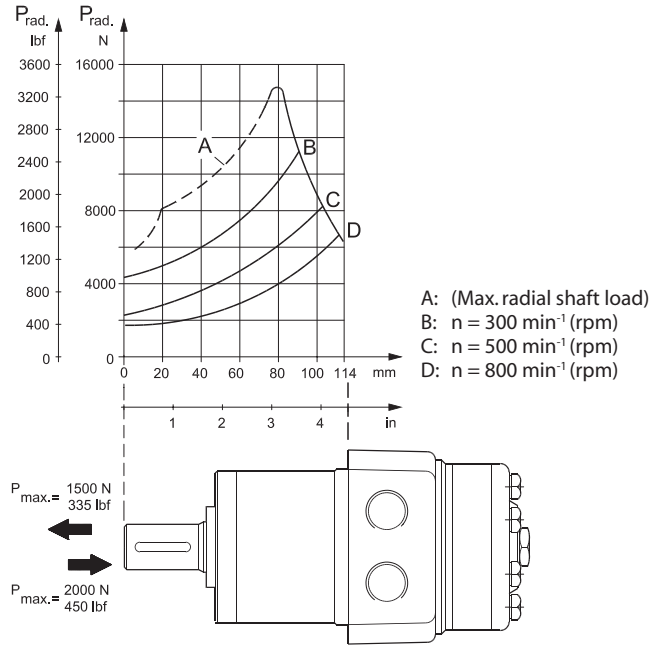

151-1389.10

The output shaft on OMPW can be offered in slide bearings similar to the other OMP-motors. The permissible higher radial load is therefore due to the recessed mounting flange moving the point of load closer to the motor bearings.

The permissible radial load on the shaft is shown for different speeds as a function of the distance from the mounting flange to the point of load application.

The curves are not based on calculations of B10 bearing life. They represent absolute limits that must not be exceeded.

Curve A indicates the max. radial shaft load. Any shaft load exceeding the values quoted in curve A will involve risk of breakage.

**PERMISSIBLE SHAFT
LOAD FOR OMPW N WITH
NEEDLE BEARING**

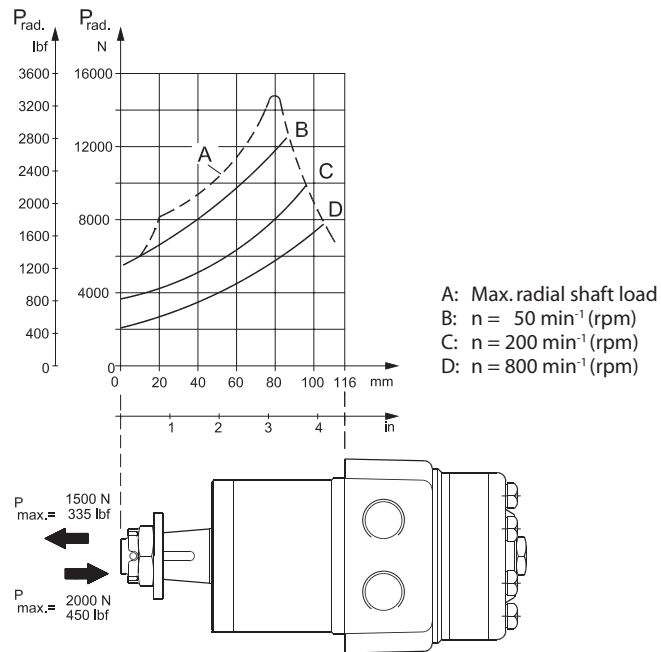

151-1387.10

The output shaft on OMPW N can be offered in needle bearings. These bearings and the recessed mounting flange allow a higher permissible radial load in comparison to OMP motors.

The permissible radial load on the shaft is shown for different speeds as a function of the distance from the mounting flange to the point of load application.

Curve A indicates the max. radial shaft load. Any shaft load exceeding the values quoted in curve A will involve risk of breakage.

The other curves apply to a B10 bearing life of 2000 hours at the number of revolutions indicated by the curve letter. Mineral based hydraulic oil with a sufficient content of anti-wear additives must be used.

Bearing life calculations can be made using the explanation and formula provided in the chapter "Bearing dimensioning" in the technical information "General" DHMH.PK.100.G2.02 520L0232.

FUNCTION DIAGRAMS

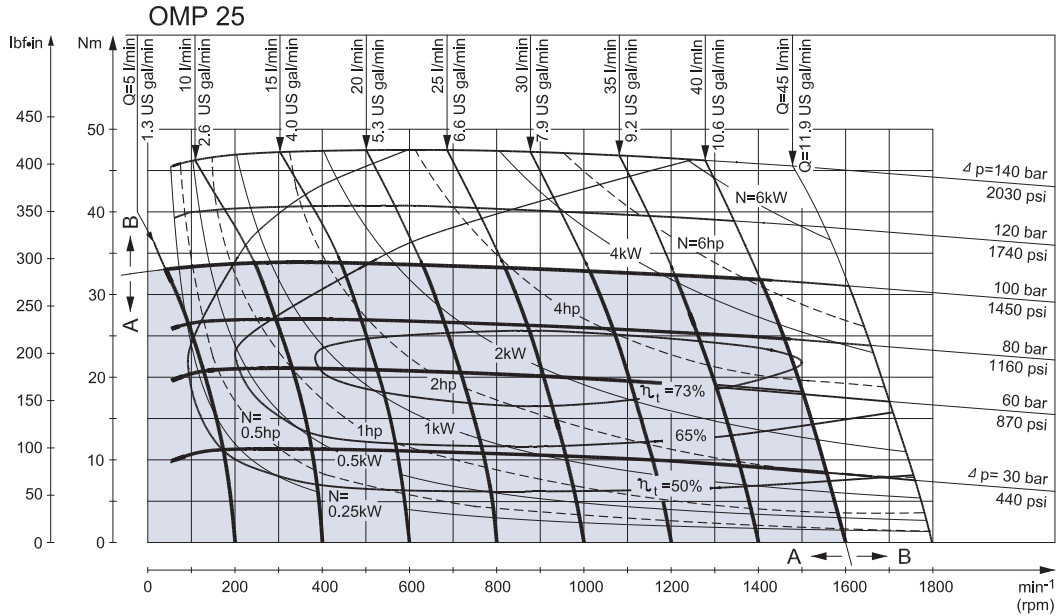

151-1369.10

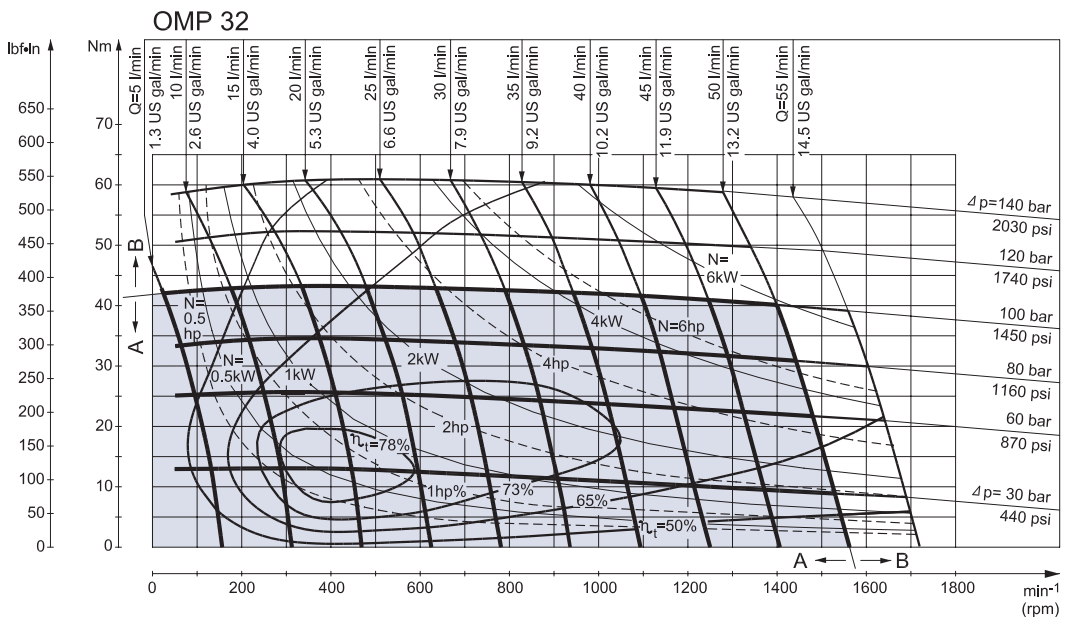

151-1383.10

Explanation of function diagram use, basis and conditions can be found on page 7.

- A: Continuous range
- B: Intermittent range (max. 10% operation every minute)

Max. permissible continuous/intermittent pressure drop for the actual shaft version can be found on page 10-12.

Note: Intermittent pressure drop and oil flow must not occur simultaneously.

FUNCTION DIAGRAMS

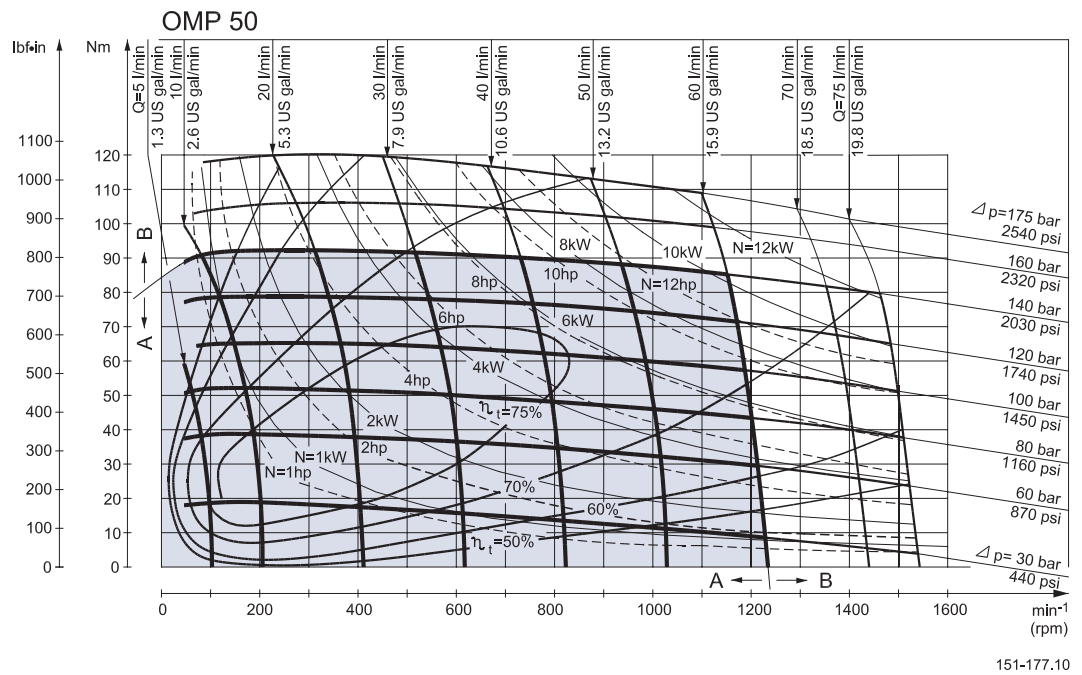
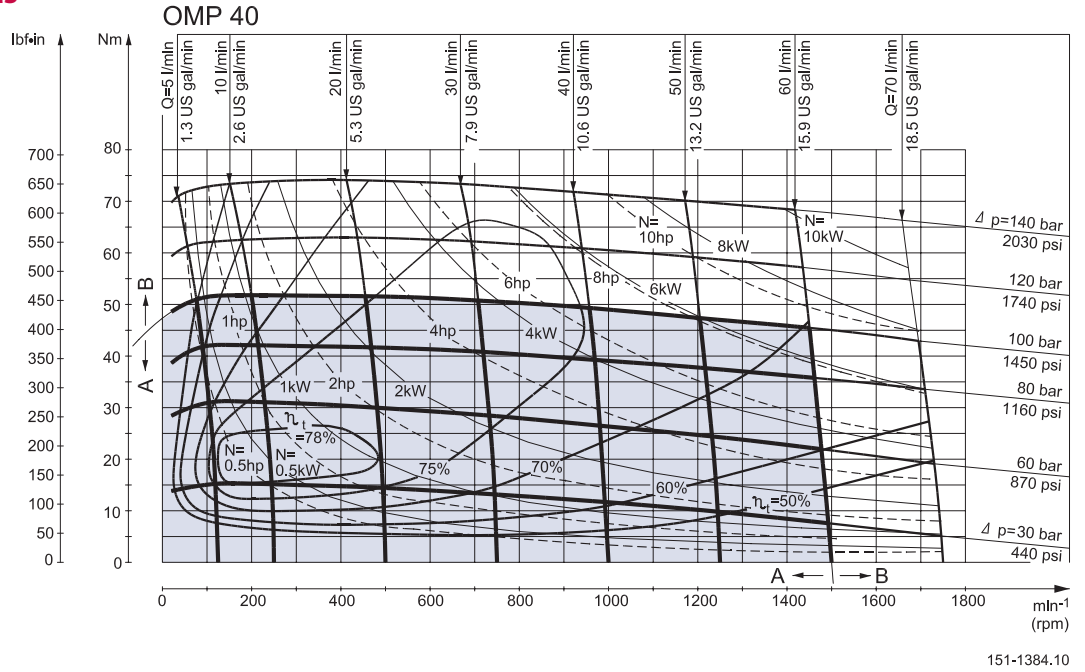

Explanation of function diagram use, basis and conditions can be found on page 7.

- A: Continuous range
- B: Intermittent range (max. 10% operation every minute)

Max. permissible continuous/intermittent pressure drop for the actual shaft version can be found on page 10-12.

Note: Intermittent pressure drop and oil flow must not occur simultaneously.

FUNCTION DIAGRAMS

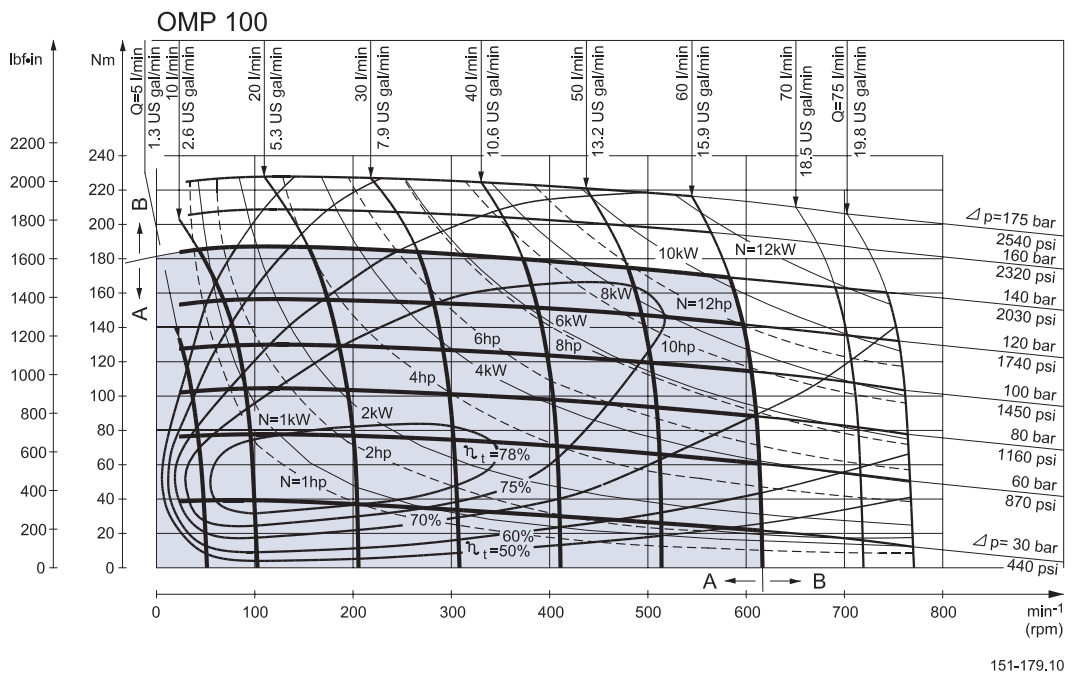
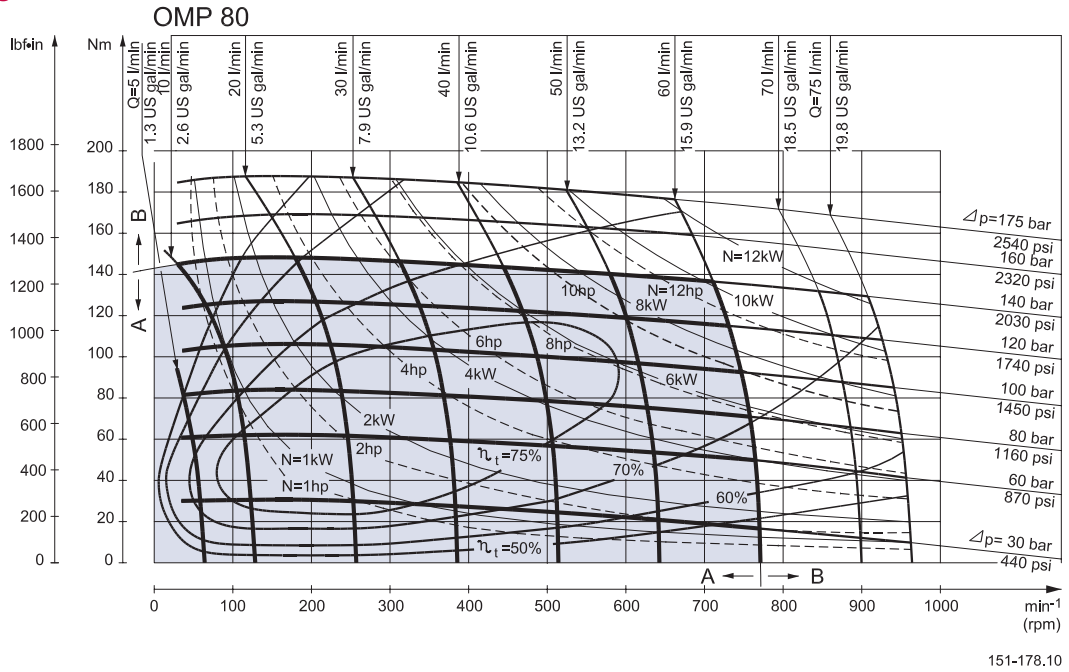

Explanation of function diagram use, basis and conditions can be found on page 7.

- A: Continuous range
- B: Intermittent range (max. 10% operation every minute)

Max. permissible continuous/intermittent pressure drop for the actual shaft version can be found on page 10-12.

Note: Intermittent pressure drop and oil flow must not occur simultaneously.

FUNCTION DIAGRAMS

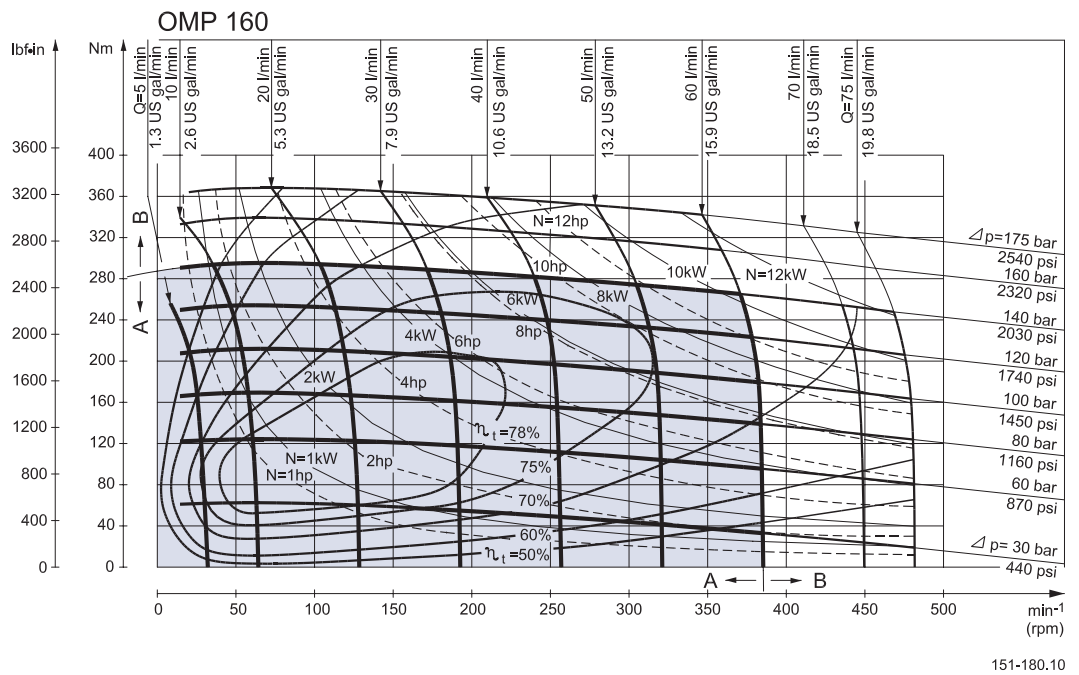
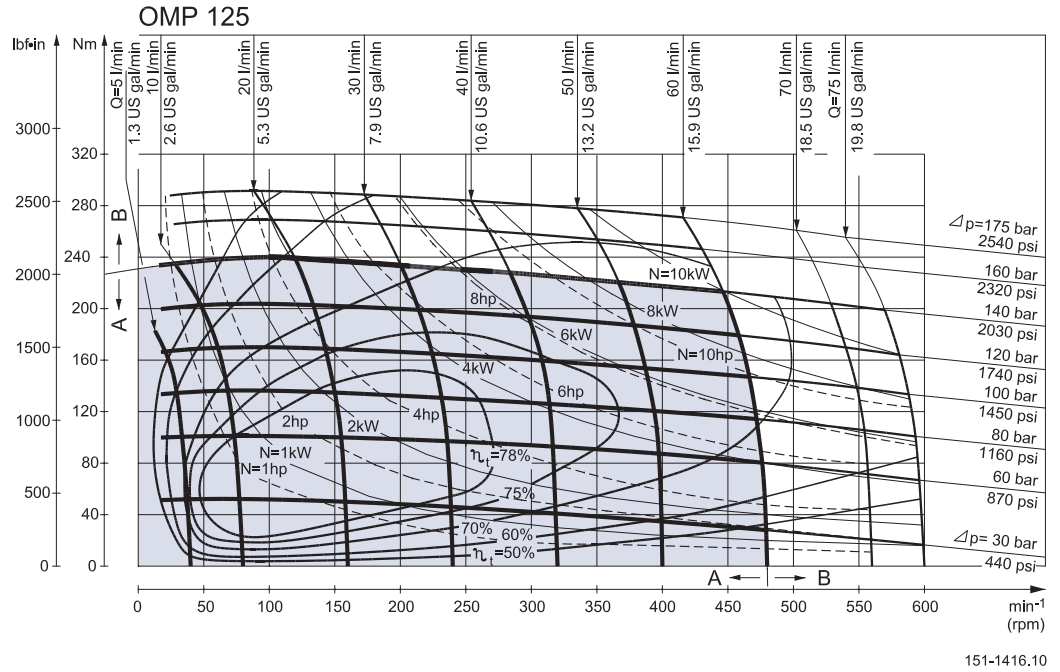

Explanation of function diagram use, basis and conditions can be found on page 7.

- A: Continuous range
- B: Intermittent range (max. 10% operation every minute)

Max. permissible continuous/intermittent pressure drop for the actual shaft version can be found on page 10-12.

Note: Intermittent pressure drop and oil flow must not occur simultaneously.

FUNCTION DIAGRAMS

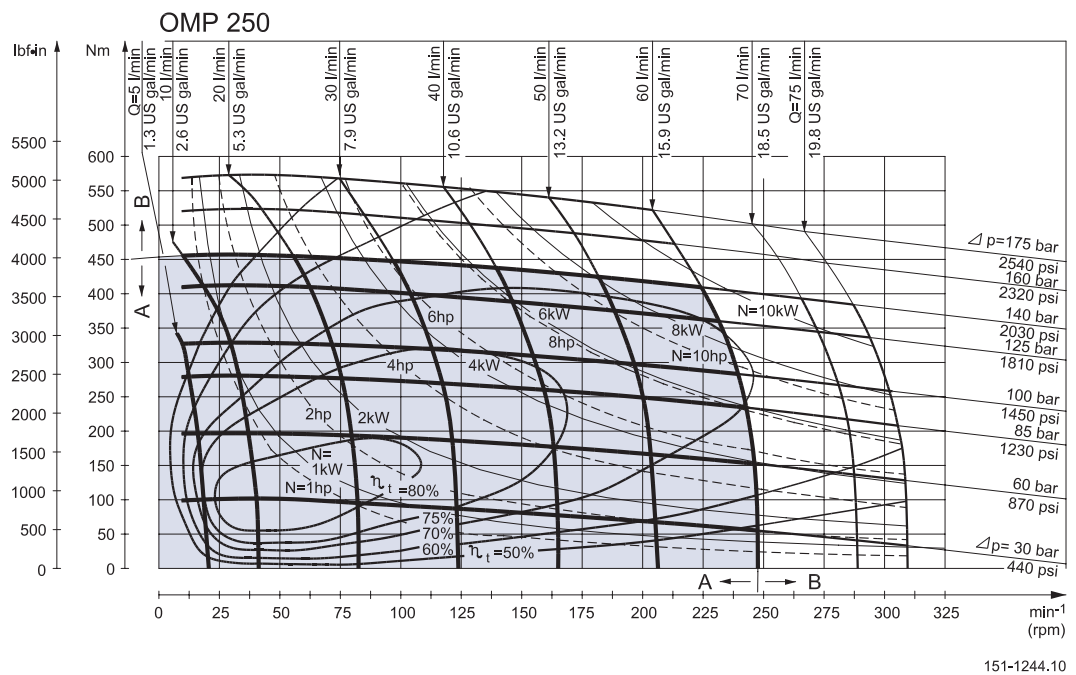
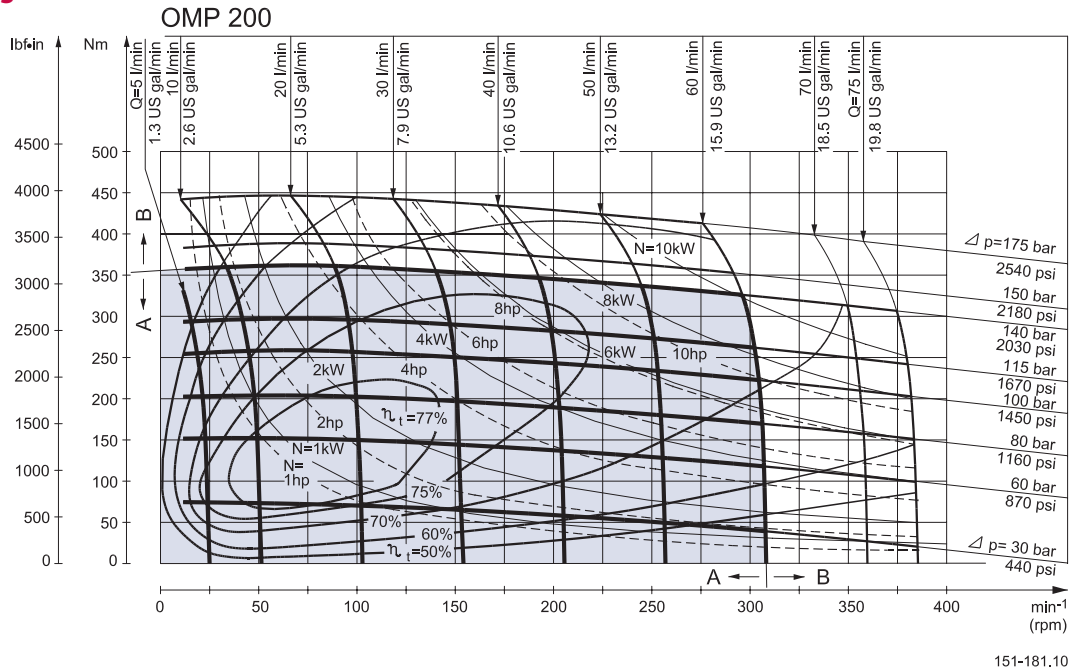

Explanation of function diagram use, basis and conditions can be found on page 7.

- A: Continuous range
- B: Intermittent range (max. 10% operation every minute)

Max. permissible continuous/intermittent pressure drop for the actual shaft version can be found on page 10-12.

Note: Intermittent pressure drop and oil flow must not occur simultaneously.

FUNCTION DIAGRAMS

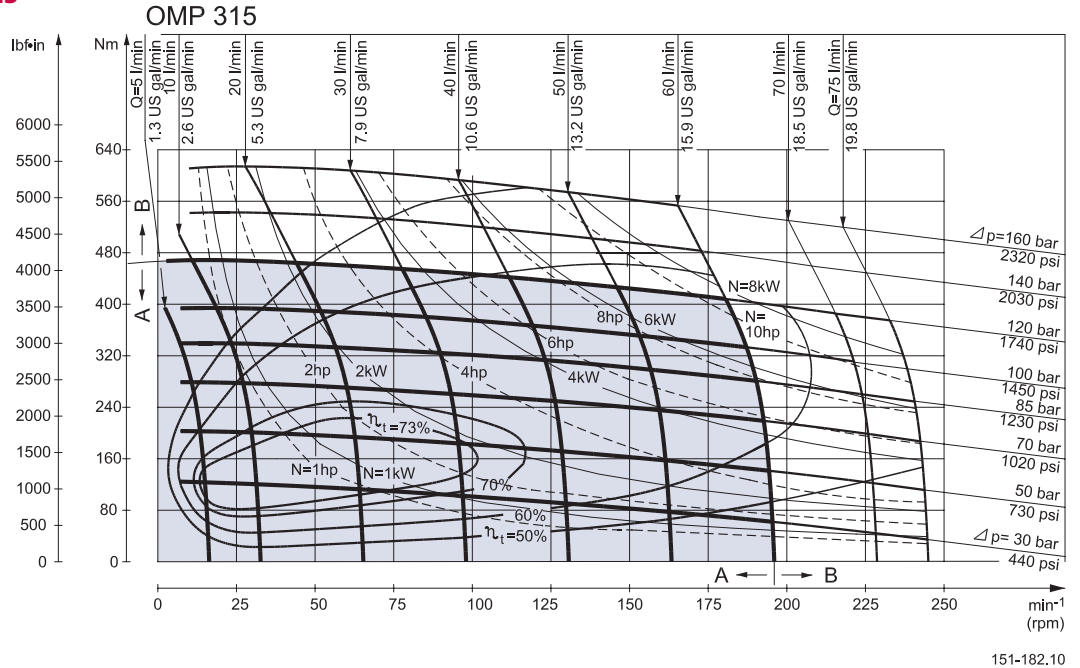

151-182.10

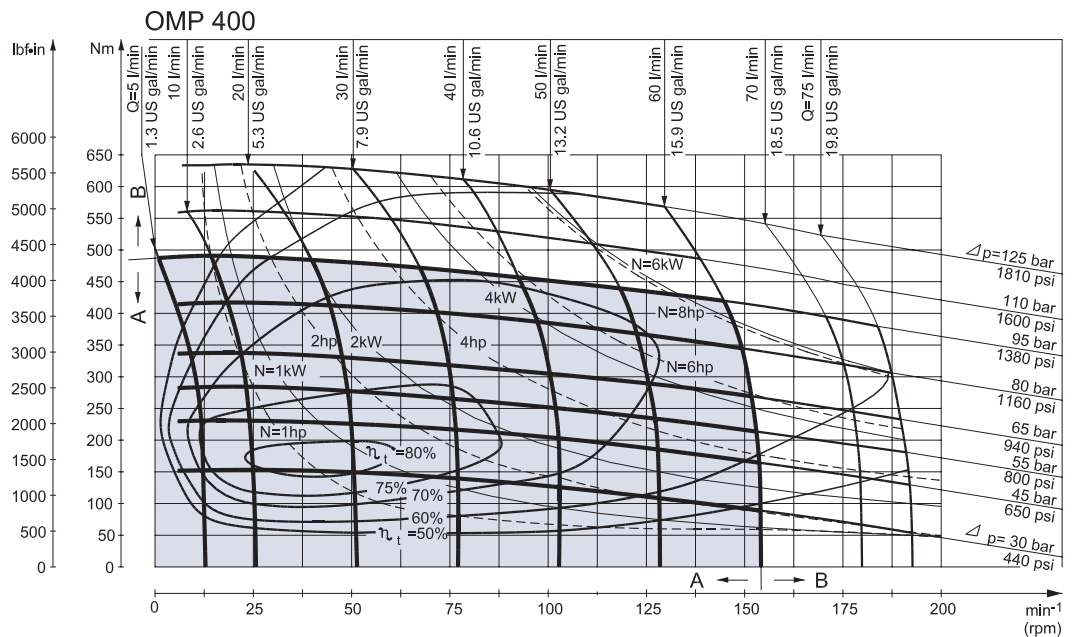

151-1161.10

Explanation of function diagram use, basis and conditions can be found on page 7.

- A: Continuous range
- B: Intermittent range (max. 10% operation every minute)

Max. permissible continuous/intermittent pressure drop for the actual shaft version can be found on page 10-12.

Note: Intermittent pressure drop and oil flow must not occur simultaneously.

SHAFT VERSION

A: Cylindrical shaft
25 mm
D: Parallel key
A8 × 7 × 32
DIN 6885

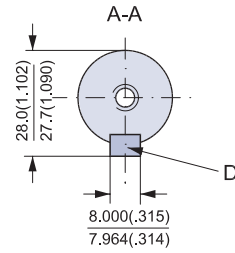
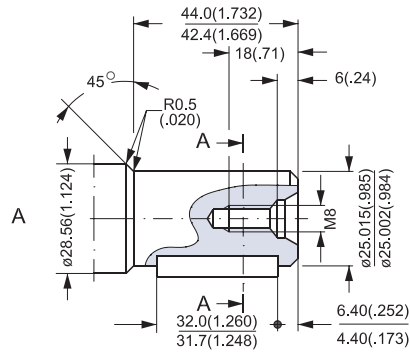

B: Cylindrical shaft
1 in
E: Parallel key
1/4 × 1/4 × 1 1/4 in
B.S. 46

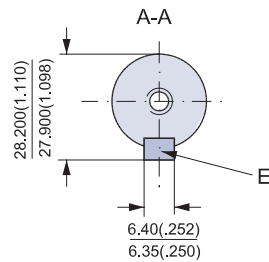
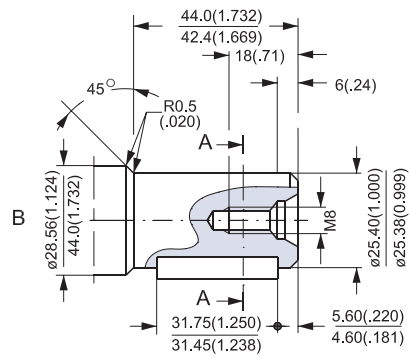

US version
C: Cylindrical shaft
1 in
F: Parallel key
1/4 × 1/4 × 1 1/4 in
B.S. 46

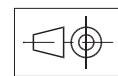
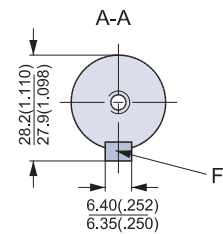
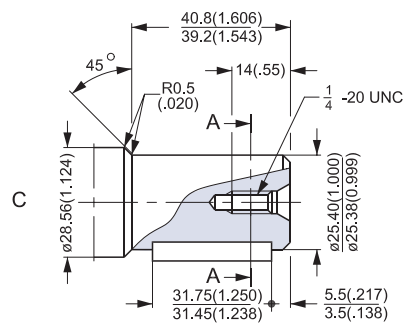

151-1842.10

SHAFT VERSION

- D: Cylindrical shaft
32 mm
- I: Parallel key
A10 × 8 × 45
DIN 6885

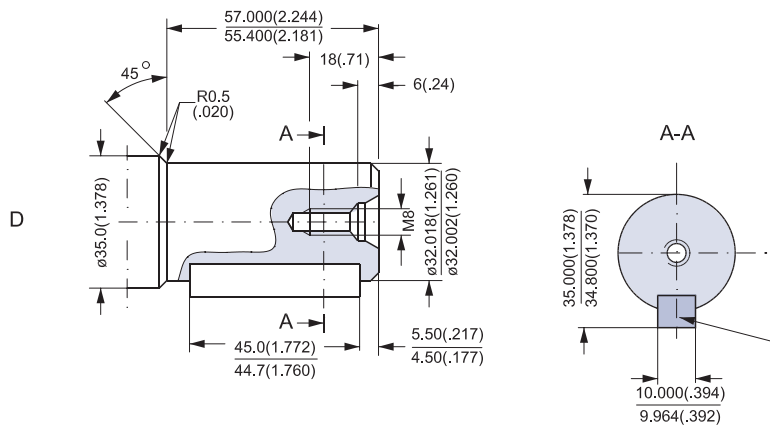

- E: Splined shaft
B.S. 2059 (SAE 6 B)
Straight-sided,
bottom fitting, dep.
Fit 2
Nom. size 1 in
* Deviates from
BS 2059 (SAE 6B)

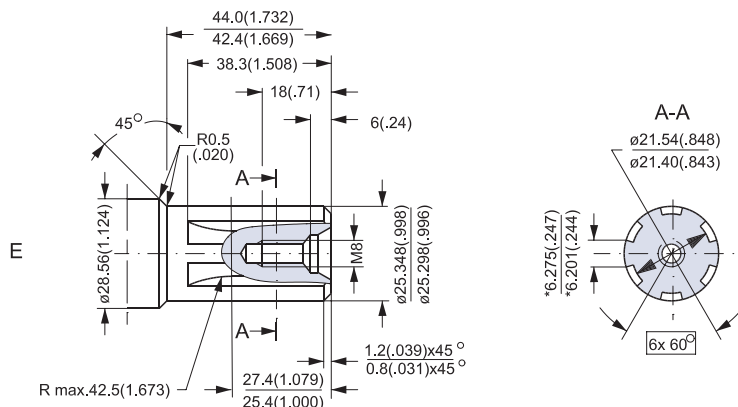

- F: Tapered shaft
(ISO/R775) →
- H: DIN 937
NV 30
Tightening torque:
100 ± 10 Nm
- G: Taper 1:10
- J: Parallel key
B5 × 5 × 14
DIN 6885

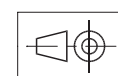
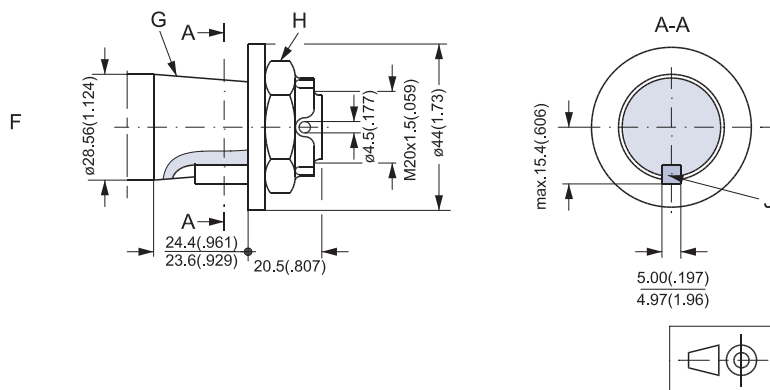

151-1843.10

PORT THREAD VERSIONS

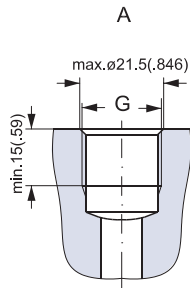

A: G main ports
G: ISO 228/1 - G¹/₂

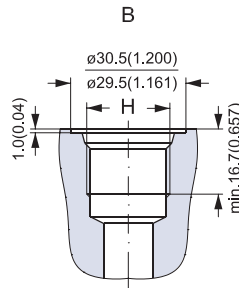

B: UNF main ports
H: ⁷/₈ - 14 UNF
O-ring boss port

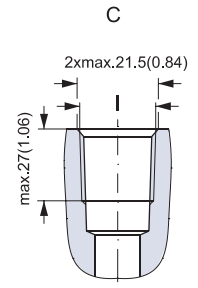

C: NPTF main ports
I: ¹/₂ - 14 NPTF

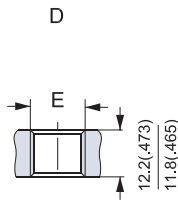

D: G drain port
E: ISO 228/1 - G¹/₄

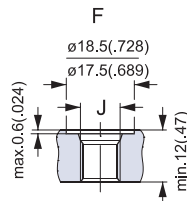

F: UNF drain port
J: ⁷/₁₆ - 20 UNF
O-ring boss port

151-1844.10

DIMENSIONS

Side port version with 2 hole oval mounting flange (A2-flange).

Type	L mm (in)	L ₁ mm (in)
OMP 25	129.0 (5.08)	4.1 (0.16)
OMP 32	130.0 (5.12)	5.2 (0.20)
OMP 40	131.0 (5.16)	6.5 (0.26)
OMP 50	131.0 (5.16)	6.5 (0.26)
OMP 80	135.0 (5.31)	10.4 (0.41)
OMP 100	137.5 (5.41)	13.0 (0.51)
OMP 125	141.0 (5.55)	16.7 (0.66)
OMP 160	145.5 (5.73)	20.8 (0.82)
OMP 200	150.5 (5.93)	26.0 (1.02)
OMP 250	157.0 (6.18)	32.5 (1.28)
OMP 315	165.5 (6.52)	40.9 (1.61)
OMP 400	176.6 (6.95)	52.0 (2.05)

C: Drain connection
G¹/₄; 12 mm (0.47 in) deep
D: G¹/₂; 15 mm (0.59 in) deep
E: M8; 13 mm (0.51 in) deep
(4 pcs.)

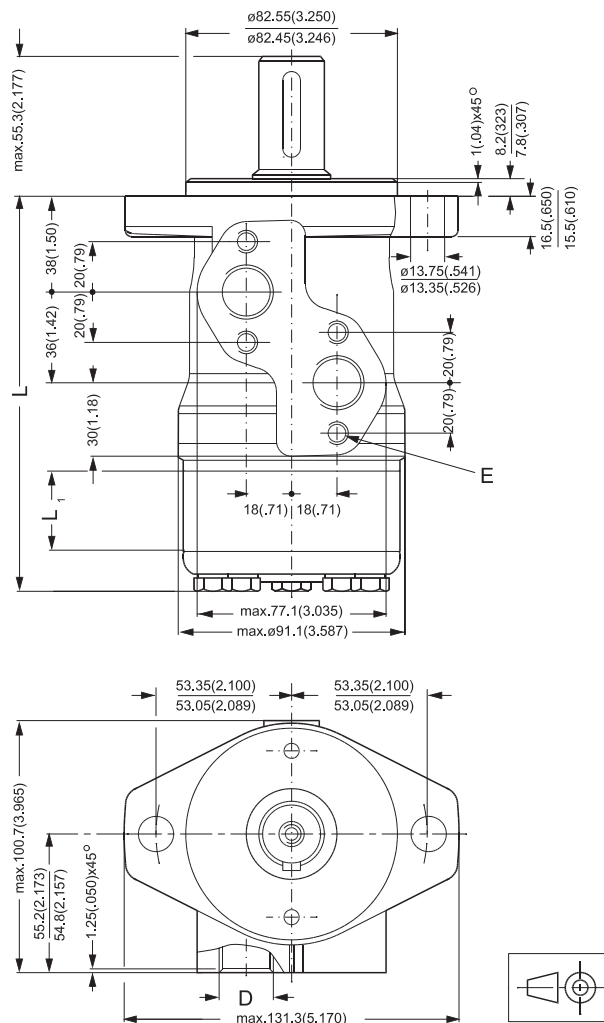

DIMENSIONS

Side port version with 2 hole oval mounting flange (A2-flange).
With drain connection.

Type	L mm (in)	L ₁ mm (in)
OMP 25	129.0 (5.08)	4.1 (0.16)
OMP 32	130.0 (5.12)	5.2 (0.20)
OMP 40	131.0 (5.16)	6.5 (0.26)
OMP 50	131.0 (5.16)	6.5 (0.26)
OMP 80	135.0 (5.31)	10.4 (0.41)
OMP 100	137.5 (5.41)	13.0 (0.51)
OMP 125	141.0 (5.55)	16.7 (0.66)
OMP 160	145.5 (5.73)	20.8 (0.82)
OMP 200	150.5 (5.93)	26.0 (1.02)
OMP 250	157.0 (6.18)	32.5 (1.28)
OMP 315	165.5 (6.52)	40.9 (1.61)
OMP 400	176.6 (6.95)	52.0 (2.05)

- C: Drain connection
G 1/4; 12 mm (0.47 in) deep
- D: G 1/2; 15 mm (0.59 in) deep
- E: M8; 13 mm (0.51 in) deep
(4 pcs.)

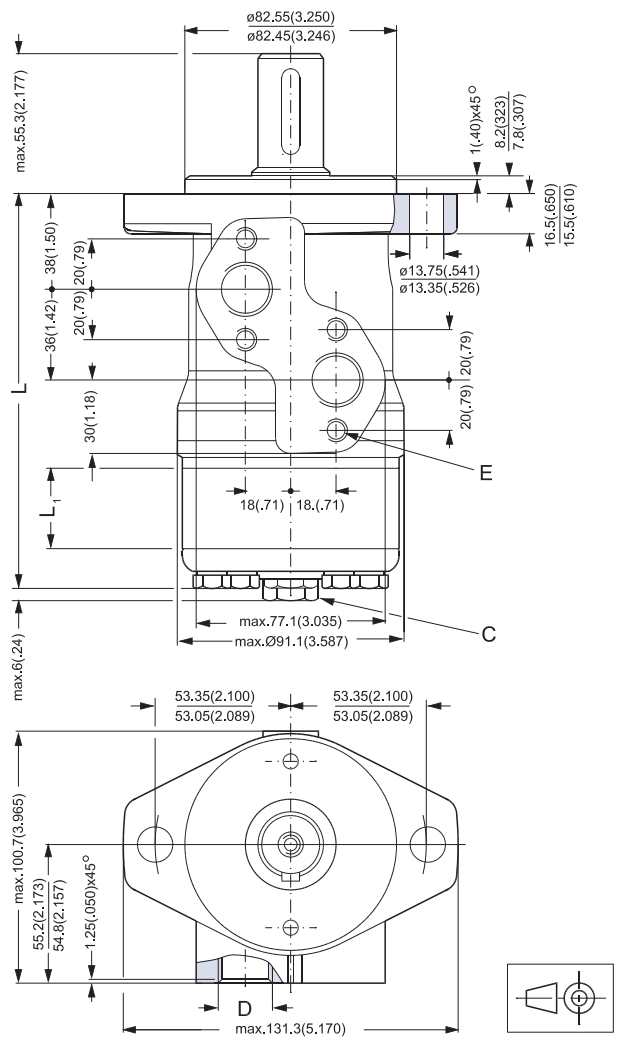

DIMENSIONS

OMP C
Side port version with 2 hole oval mounting flange (A2-flange).

Type	L mm (in)	L ₁ mm (in)
OMP 50	131.0 (5.16)	6.5 (0.26)
OMP 80	135.0 (5.31)	10.4 (0.41)
OMP 100	137.5 (5.41)	13.0 (0.51)
OMP 125	141.0 (5.55)	16.7 (0.66)
OMP 160	145.5 (5.73)	20.8 (0.82)
OMP 200	150.5 (5.93)	26.0 (1.02)
OMP 250	157.0 (6.18)	32.5 (1.28)
OMP 315	165.5 (6.52)	40.9 (1.61)
OMP 400	176.6 (6.95)	52.0 (2.05)

C: Drain connection
G¹/₄; 12 mm (0.47 in) deep
D: G¹/₂; 15 mm (0.59 in) deep
E: M8; 13 mm (0.51 in) deep
(4 pcs.)

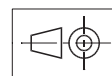
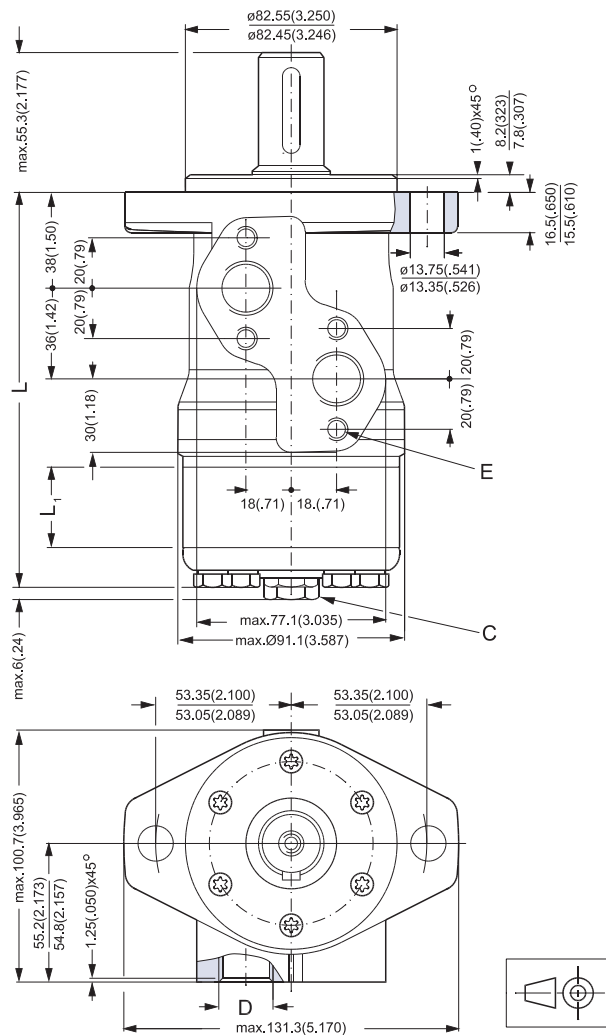

151-1841.10

DIMENSIONS

End port version with 2 hole oval mounting flange (A2-flange).

Type	L mm (in)	L ₁ mm (in)
OMP 50	145.1 (5.71)	6.5 (0.26)
OMP 80	149.0 (5.87)	10.4 (0.41)
OMP 100	151.7 (5.97)	13.0 (0.51)
OMP 125	155.2 (6.11)	16.3 (0.66)
OMP 160	159.4 (6.28)	20.8 (0.82)
OMP 200	164.6 (6.48)	26.0 (1.02)
OMP 250	171.1 (6.74)	32.5 (1.28)
OMP 315	179.5 (7.07)	40.9 (1.61)
OMP 400	190.6 (7.50)	52.0 (2.05)

C: Drain connection
G 1/4; 12 mm (0.47 in) deep
D: G 1/2; 15 mm (0.59 in) deep

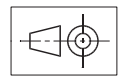
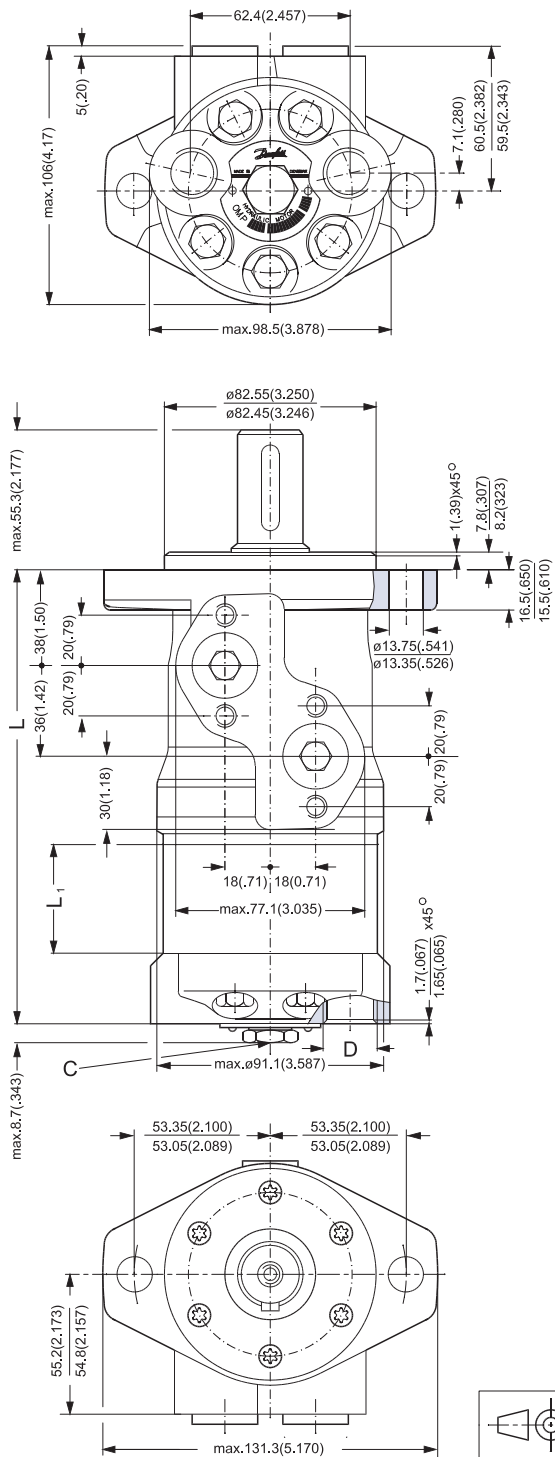

151-1748.10

DIMENSIONS

Side port version with 2 hole oval mounting flange (A2-flange).

Type	L mm (in)	L ₁ mm (in)
OMP 25	135.0 (5.31)	4.1 (0.16)
OMP 32	136.0 (5.35)	5.2 (0.20)
OMP 40	137.0 (5.39)	6.5 (0.26)
OMP 50	137.0 (5.39)	6.5 (0.26)
OMP 80	141.0 (5.55)	10.4 (0.41)
OMP 100	143.5 (5.65)	13.0 (0.51)
OMP 125	147.0 (5.79)	16.7 (0.66)
OMP 160	151.5 (5.96)	20.8 (0.82)
OMP 200	156.5 (6.16)	26.0 (1.02)
OMP 250	163.0 (6.42)	32.5 (1.28)
OMP 315	171.5 (6.75)	40.9 (1.61)
OMP 400	182.6 (7.19)	52.0 (2.05)

- C: Drain connection
7/16 - 20 UNF;
12 mm (0.47 in) deep
- D: 7/8 - 14 UNF;
16.7 mm (0.66 in) deep
or 1/2 - 14 NPTF
- E: M8; 13 mm (0.51 in) deep
(4-off)

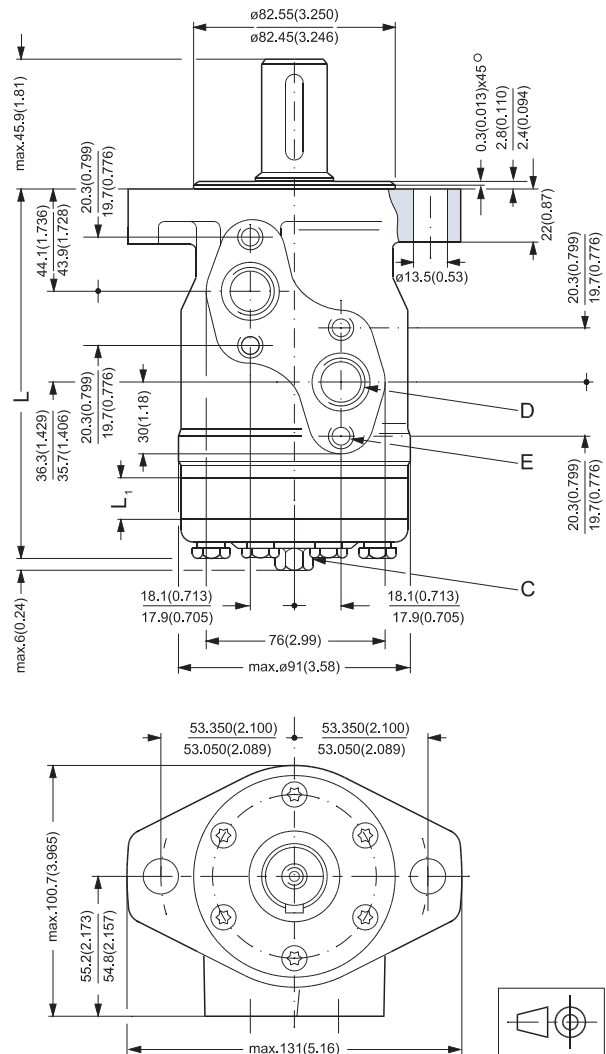

151-1217.10

DIMENSIONS

Side port version with 4 hole oval mounting flange (A4-flange).

Type	L mm (in)	L ₁ mm (in)
OMP 50	131.0 (5.16)	6.5 (0.26)
OMP 80	135.0 (5.31)	10.4 (0.41)
OMP 100	137.5 (5.41)	13.0 (0.51)
OMP 125	141.0 (5.55)	16.7 (0.66)
OMP 160	145.5 (5.73)	20.8 (0.82)
OMP 200	150.5 (5.93)	26.0 (1.02)
OMP 250	157.0 (6.18)	32.5 (1.28)
OMP 315	165.5 (6.52)	40.9 (1.61)
OMP 400	176.6 (6.95)	52.0 (2.05)

- C: Drain connection
G 1/4; 12 mm (0.47 in) deep
- D: G 1/2; 15 mm (0.59 in) deep
- E: M8; 13 mm (0.51 in) deep
(4 pcs.)

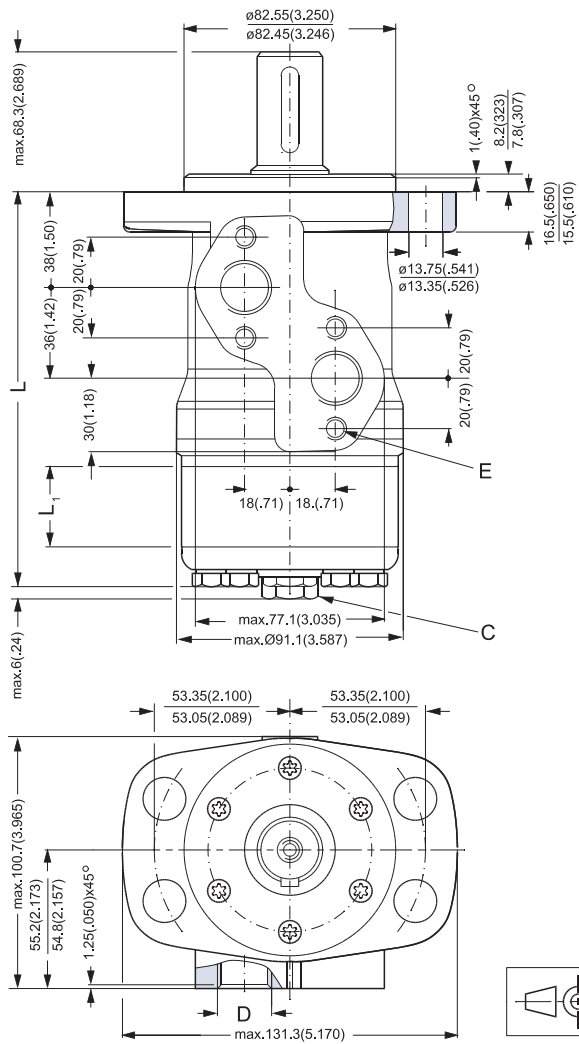

151-1747.10

DIMENSIONS

End port version with square mounting flange (C-flange).

Type	L mm (in)	L ₁ mm (in)
OMP 50	151.1 (5.94)	6.5 (0.26)
OMP 80	155 (6.10)	10.4 (0.41)
OMP 100	157.6 (6.20)	13.0 (0.51)
OMP 125	161.1 (6.34)	16.7 (0.66)
OMP 160	165.4 (6.51)	20.8 (0.82)
OMP 200	170.6 (6.72)	26.0 (1.02)
OMP 250	177.1 (6.97)	32.5 (1.28)
OMP 315	185.5 (7.30)	40.9 (1.61)
OMP 400	196.6 (7.74)	52.0 (2.05)

- C: Drain connection
G 1/4; 12 mm (0.47 in) deep
- D: G 1/2; 15 mm (0.59 in) deep
- E: M10; 15 mm (0.59 in) deep
(4 pcs.)

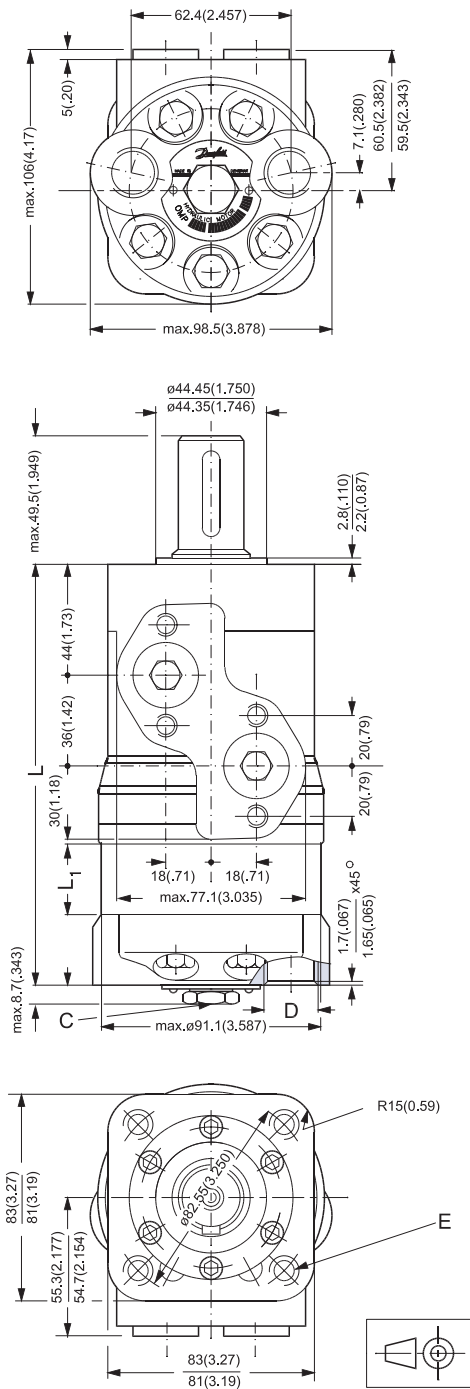

151-1749.10

DIMENSIONS

Side port version with square mounting flange (C-flange).

Type	L mm (in)	L ₁ mm (in)
OMP 50	131.0 (5.16)	6.5 (0.26)
OMP 80	135.0 (5.31)	10.4 (0.41)
OMP 100	137.5 (5.41)	13.0 (0.51)
OMP 125	141.0 (5.55)	16.7 (0.66)
OMP 160	145.5 (5.73)	20.8 (0.82)
OMP 200	150.5 (5.93)	26.0 (1.02)
OMP 250	157.0 (6.18)	32.5 (1.28)
OMP 315	165.5 (6.52)	40.9 (1.61)
OMP 400	176.6 (6.95)	52.0 (2.05)

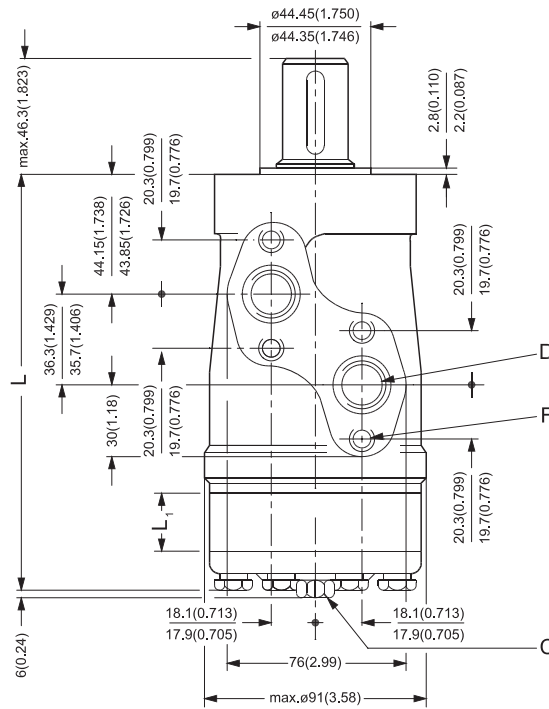

- C: Drain connection
7/16 - 20 UNF;
11.94 mm (0.47 in) deep
- D: 7/8 - 14 UNF;
16.76 mm (0.66 in) deep
or 1/2 - 14 NPTF
- E: 3/8 - 16 UNC;
14.97 mm (0.59 in) deep
(4-off)
- F: M8; 12.95 mm (0.51 in) deep
(4-off)

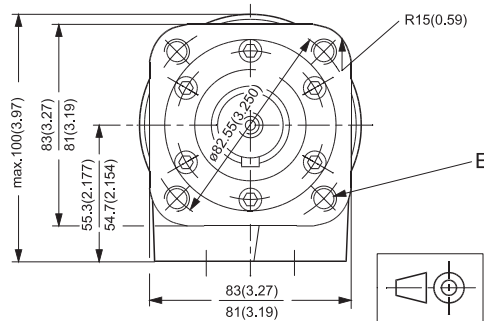

151-1214.10

DIMENSIONS

OMPW

OMPW N

Type	mm L ₂ (in)
OMPW with Ø25 mm shaft	115.0 (4.53)
OMPW N with tapered shaft	116.0 (4.57)

Type	L mm (in)	L ₁ mm (in)
OMP 50	70.8 (2.78)	6.5 (0.26)
OMP 80	74.7 (2.97)	10.4 (0.41)
OMP 100	77.3 (3.04)	13.0 (0.51)
OMP 125	80.6 (3.17)	16.7 (0.66)
OMP 160	85.1 (3.35)	20.8 (0.82)
OMP 200	90.3 (3.56)	26.0 (1.02)
OMP 250	96.8 (3.81)	32.5 (1.28)
OMP 315	105.2 (4.14)	40.9 (1.61)
OMP 400	116.3 (4.58)	52.0 (2.05)

- C: Drain connection
G 1/4; 12 mm (0.47 in) deep
- D: G 1/2; 15 mm (0.59 in) deep
- E: M10; 20 mm (0.79 in) deep
(4 pcs.)

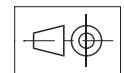
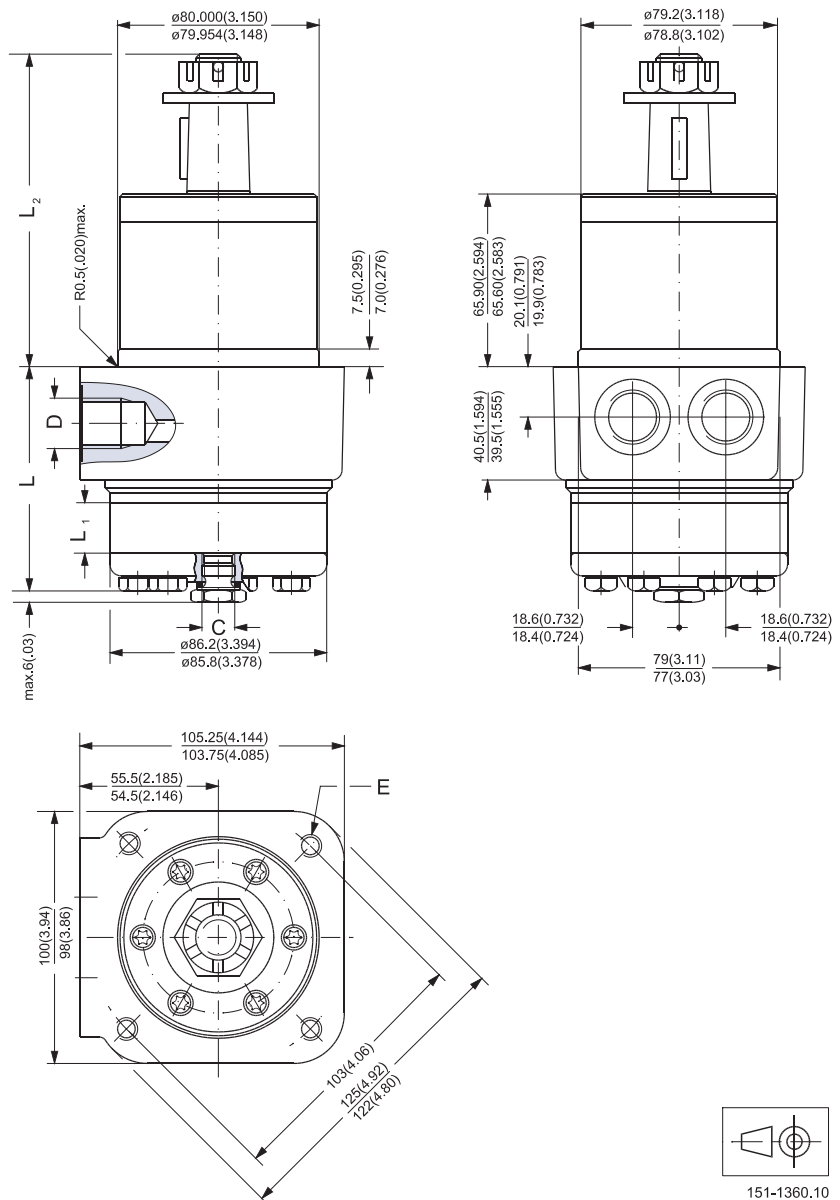

151-1360.10



Our international sales network covers every jurisdiction. Our global shipping partners mean you can be sure we're on hand whenever you need us.

Zeus Hydratech Ltd

Unit 35
Old Mills Industrial Estate
Paulton
Bristol, BS39 7SU
United Kingdom

T. +44 (0) 1172 130042
E: info@zeushydratech.com
W. www.zeushydratech.com