

Instruction Manual

DAIKIN Oil Cooling Unit ("OILCON")

AKZ8 Series Circulating type

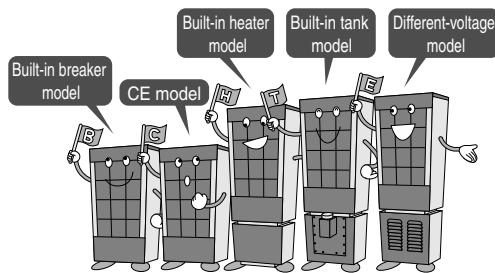
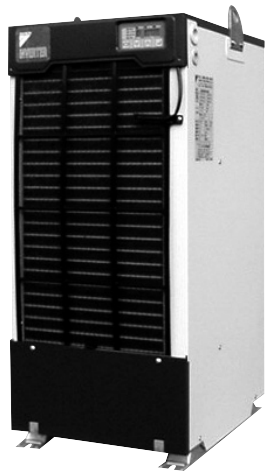

Models

Menu Series	Standard model	Built-in breaker model (-B)	CE model (-C)	Built-in heater model (-H)	Different-voltage model (-E)	Built-in tank model (-T1, -T)
AKZ148	<input type="checkbox"/>	<input type="checkbox"/>	<input type="checkbox"/>	<input type="checkbox"/>	<input type="checkbox"/>	<input type="checkbox"/>
AKZ328	<input type="checkbox"/>	<input type="checkbox"/>	<input type="checkbox"/>	<input type="checkbox"/>	<input type="checkbox"/>	<input type="checkbox"/>
AKZ438	<input type="checkbox"/>	<input type="checkbox"/>	<input type="checkbox"/>	<input type="checkbox"/>	<input type="checkbox"/>	<input type="checkbox"/>
AKZ568	<input type="checkbox"/>	<input type="checkbox"/>	<input type="checkbox"/>	<input type="checkbox"/>	<input type="checkbox"/>	<input type="checkbox"/>
AKZ908	<input type="checkbox"/>	<input type="checkbox"/>	<input type="checkbox"/>	<input type="checkbox"/>	<input type="checkbox"/>	<input type="checkbox"/>

Thank you for purchasing DAIKIN Oil Cooling Unit ("OILCON"). This instruction manual includes instructions for using the Oil Cooling Unit.

To ensure proper use of this product, be sure to read through this instruction manual before using it.

After reading this manual, keep it handy for your future reference.

Proper use results in power saving

If the air filter is clogged, the cooling performance deteriorates, causing excess power consumption.

Clean the air filter periodically to reduce power consumption.

CONTENTS

Safety Precautions 1

Installation

Oil Cooling Unit and Accessories 4
 Precautions for Installation 5
 Reference for Pipe Selection 6
 Electric Wiring 7

Handling

Model Identification and Specifications 12
 Before Operation 14
 Part Names and Functions 15
 Names and Functions of the Control Panel Parts 16
 Checking Initial Operating Conditions 18
 Operation Setting 19

Holding Constant Oil Temperature 20
 Tuning Oil Temperature to Room Temperature (or Machine Temperature) 21
 Cooling Oil at Constant Capacity (%) 22

Monitor Items 23
 Timer Operation 24
 Additional Setting Functions 25
 Setting Additional Function 27
 For Temperature Control Improvement 30
 Alarm/Warning Output Logic 33
 Alarm Settings for Optional Protection Devices (Installed by User) 33

Optional Parts

Machine temperature tuning control 34
 Returned oil temperature control 35
 Communication with main machine 36

Maintenance

Maintenance/Inspection 37
 • Daily maintenance/inspection
 • Periodic maintenance/inspection
 • To leave the unit unused for a long period

Troubleshooting 38
 • When the unit operation seems abnormal although no alarm is activated
 • When an alarm is activated

Installation Procedure

Before Operation

Operating Procedure

Useful Functions

Optional Functions

Maintenance

Troubleshooting

Safety Precautions Before using this product, read the following instructions carefully to ensure proper use.

- The instructions described below are intended to prevent injury or damage to you and other people. Possible conditions that may result from improper handling are classified as follows:

 **DANGER**

This category indicates urgently **hazardous conditions that may result in death or serious injury.**

 **WARNING**

This category indicates **potentially hazardous conditions that may result in death or serious injury.**

 **CAUTION**





This category indicates **potentially hazardous conditions that may result in injury or property damage only.**

- All these instructions include important information on safety. Be sure to observe the instructions.
- **After reading this manual, be sure to keep it in place so that users can read it whenever required.**
- If this product is transferred to another person, be sure to attach this manual to the product.
- To use this product safely, be sure to observe the following instructions, and safety laws and regulations for the relevant standards listed below.



1. Industrial Safety and Health Law
2. Fire Service Law
3. JIS B8361 General Rules for Hydraulic Systems

Precautions for installation

 **DANGER**

<p>Only qualified people can handle the unit.</p> <p> Transportation, installation, piping, electric wiring, operation, maintenance and inspection of the unit must be conducted by qualified people.</p> <p>Mandatory Check the power supply (voltage, frequency and current).</p>	<p>Check the weight, and hang the unit by the specified points.</p> <p> Check the weight of the unit with the nameplate to make sure that it does not exceed the rated load capacity of the carrier. Hang the unit by the points specified in the outline drawing. Failure to observe this instruction may result in fall or overturn of the unit, causing injury or property damage.</p> <p>Mandatory</p>
<p>Connect the power cable according to the procedure described in this instruction manual.</p> <p> Connect the power cable according to the procedure described in "Electric Wiring" on page 7.</p> <p>Forbidden</p>	<p>Ground the unit securely.</p> <p> If the unit is not grounded, you may get an electric shock.</p> <p>Ground cable connection</p>

 **WARNING**

<p>Conduct electric wiring according to the ratings.</p> <p> Conduct electric wiring according to "Regulation on Electrical Facilities" and "Internal Wiring Regulations". Improper wiring may result in burnout or fire.</p> <p>Mandatory For overseas use, conduct electric wiring according to the local wiring standard.</p>	<p>Fasten the unit during operation.</p> <p> Check the fastening points with the outline drawing, and fasten the unit securely with bolts or foundation bolts. Failure to observe this instruction may result in fall or overturn of the unit, if this unit is installed at an elevated position.</p> <p>Forbidden</p>
<p>Keep away from the unit when it is being carried with slings.</p> <p> Never get close to the unit when it is being carried with slings. Failure to observe this instruction may result in fall or overturn of the unit, causing injury or property damage.</p> <p>Forbidden</p>	

CAUTION

Prepare a circuit breaker at user's site.



Mandatory

The Oil Cooling Unit is not equipped with a circuit breaker. A circuit breaker exclusively for the Oil Cooling Unit should be provided by user. To ensure safety, it is recommended to use an earth leakage breaker. To use an earth leakage breaker, select an inverter-compatible type. (Recommended: 15 mA or 20 mA)

Provide a flow switch for the main machine.



Mandatory

If the oil pump operation system has a fault, oil cannot be supplied to the main machine. Normally in this case, the Oil Cooling Unit detects the fault and outputs an alarm signal. However, it may not be detected depending on the fault mode. If the main machine must be protected even in such a case, provide a flow switch for the oil flow path of the main machine to watch the oil flow.

Check the oil piping.



Mandatory

Before or immediately after connection of the Oil Cooling Unit, make sure that the oil piping of the main machine is not blocked (fully closed). If the unit is operated with the oil piping blocked (fully closed), the oil hose may break due to an oil temperature rise, causing oil to flow out of the Oil Cooling Unit. When the oil temperature abnormally rises, the FE or FH alarm is activated. In this case, stop operation of the main machine as soon as possible.

Precaution for using the CE model (optional)



Mandatory

The optional CE model (AKZ**8-C) Oil Cooling Unit is classified as an auxiliary machine of the main machine (Overvoltage Category II). It has been self-declared under the following conditions. Be sure to follow the specifications of the main machine.

- (1) Provide a main power supply circuit breaker for the main machine according to the EN60204-1 requirement.
- (2) Connect the power supply via a transformer with basic insulation rating*.

* Basic insulation: Insulation provided for live parts to ensure fundamental protection against electric shock (under IEC Standard 60335-1)

Do not tilt the unit.



Mandatory

During transportation (including storage), do not tilt the Oil Cooling Unit more than 30°. If the unit is tilted more than 30°, the compressor may have a fault.

Precautions for use

DANGER

Before handling this unit, turn OFF the power supply.



Mandatory

Before handling this unit, be sure to turn OFF the power supply. Handling this unit in live conditions may result in electric shock.

Do not use the unit beyond specified operating conditions.



Mandatory

Do not use this unit in any condition other than those specified in the catalog or delivery specifications. Failure to observe this instruction may result in a serious accident, such as damage to the main machine, injury, fire and electric shock.

Do not handle the unit for 5 minutes after power supply is turned OFF.



Forbidden

During this period, electric discharge from the internal high-voltage parts (capacitors) has not been completed. Failure to observe this instruction may result in electric shock.

Do not use the unit in explosive atmosphere.



Forbidden

Do not install this unit in a place where evolution, inflow, retention or leak of inflammable gas may be expected, or where airborne carbon fiber is present. Failure to observe this instruction causes fire.

Do not operate the unit with the covers opened.



Forbidden

Do not operate the Oil Cooling Unit with the unit casing or terminal covers of the motor or other electric parts removed. Failure to observe this instruction may result in electric shock.

Do not disassemble or repair the unit.



Do not disassemble

Do not modify this unit. Any person other than DAIKIN authorized service personnel must not disassemble or repair this unit. Failure to observe this instruction causes fire, electric shock or injury. If this unit is disassembled, repaired or modified by an unauthorized person, it shall not be beyond the scope of warranty.

Keep your hand or body away from the unit during operation.



Forbidden

During operation, the external panel may become extremely hot. Be careful that your hand or body does not directly touch it. Otherwise, you may get a burn.

Do not splash water.



Forbidden

Do not immerse this unit in water, or splash water on the unit. Failure to observe this instruction may result in short-circuit or electric shock.

WARNING

If refrigerant leaks, provide thorough ventilation.



Mandatory

If a large quantity of refrigerant is filled in the site, people in the site may be anesthetized or suffocated. With the CE model, MSDS (Material Safety Data Sheet) for the refrigerant is attached to the product. Take an action according to the MSDS.

If an abnormal condition occurs, stop operation immediately.



Mandatory

If an abnormal condition occurs, stop operation of the unit, and leave it unused until the cause of the trouble is securely removed. Failure to observe this instruction may result in damage to the unit, electric shock, fire or injury.

Do not put a finger or foreign object in an aperture of the unit.



Caution

To ensure safety, a cover or casing is mounted to rotary parts. Do not put a finger or foreign object in an aperture of the cover or casing. Failure to observe this instruction may result in injury.

Turn OFF the circuit breaker.



Mandatory

After stopping operation, be sure to turn OFF the circuit breaker.

Use a commercial power supply.



Mandatory

Be sure to use a commercial power supply. Using an inverter power supply may result in burnout.

When cleaning the unit, wear gloves.



Mandatory

Otherwise, you may cut your hand with the condenser fin edges. Furthermore, the internal compressor or motor frames and the refrigerant piping become extremely hot. If you touch these parts with bare hands, you may get a burn.

CAUTION

Do not use the unit in special atmosphere.



Forbidden

Do not use this unit in special atmosphere, including dust, oil mist, high temperature or high humidity.

Ensure safety of the main machine before trial run.



Mandatory

Before executing a trial run, make sure that the main machine is set in safe conditions (the main machine will not run, or no accident occurs even if the main machine runs.) Failure to observe this instruction may result in injury or damage to the machine.

Do not put an obstacle near the air intake/exhaust port.



Forbidden

Do not put an obstacle within 500 mm from the air intake/exhaust port. If air intake/exhaust flow is blocked, this unit may not provide the specified cooling capacity.

Clean the air filter periodically.



Mandatory

Clean the air filter at least every two weeks. If the air filter is clogged, the cooling capacity deteriorates, and power consumption increases.

Perform daily check for oil pollution.



Mandatory

Oil pollution causes a fault or shortened service life of the pump. Use thorough caution about oil pollution to maintain the pollution degree at NAS10 or lower level.

Cancel operation lock before running the main machine.



Mandatory

Before you start running the main machine, cancel the operation lock status with the Oil Cooling Unit operation panel. If you start the main machine in the operation lock status, it cannot be supplied with oil, causing damage to the machine.

Do not step on the unit.



Forbidden

Do not sit or step on this unit. Failure to observe this instruction may result in fall or overturn of the unit, causing injury.

Do not run the pump without oil.



Forbidden

Before start of operation, make sure that the oil pipe is properly connected, and the tank is filled with oil to an appropriate level. Running the pump without oil results in damage to the pump.

During transportation, fasten the unit securely.



Mandatory

Fasten this unit securely so that it will not be moved by vibration or external force during transportation. If storing vibration or external force is applied to the unit, the internal equipment may be damaged.

Check the unit before operation.



Check

Before start of operation, make sure that the oil piping and electric wiring are properly conducted, and connecting parts are securely tightened.

Oil Cooling Unit and Accessories

Check the following items:

1 Oil Cooling Unit

Check the model name and serial No. (MFG. No.) on the nameplate attached to the right side of the Oil Cooling Unit.

2 Accessories

An accessory package*1 is attached to the top plate of the Oil Cooling Unit. Make sure that the following items are included in the accessory package.

1. Instruction manual (This document): 1 volume

Keep this manual in place where users can read it whenever required.

2. Rubber bushing for electric wiring (Large size, with cross slit): 1 pc.

When connecting the power cable, remove the resin cable hole cap in the side plate of the unit, and attach the rubber bushing. It is only for provisional use.*2

3. Rubber bushing for electric wiring (Small size, with cross slit): 1 pc.

When connecting the signal cable, remove the resin cable hole cap in the side plate of the unit, and attach the rubber bushing. It is only for provisional use.*2

*1: Before operation, be sure to remove the accessory package. Otherwise, the package blocks exhaust air flow, resulting in cooling capacity deterioration.

*2: **When connecting each cable finally, place the cable in a conduit.** If the rubber bushing is used, the dust-proof effect of the electrical equipment box deteriorates, causing a fault. For details, refer to "Wiring procedure" on page 8.

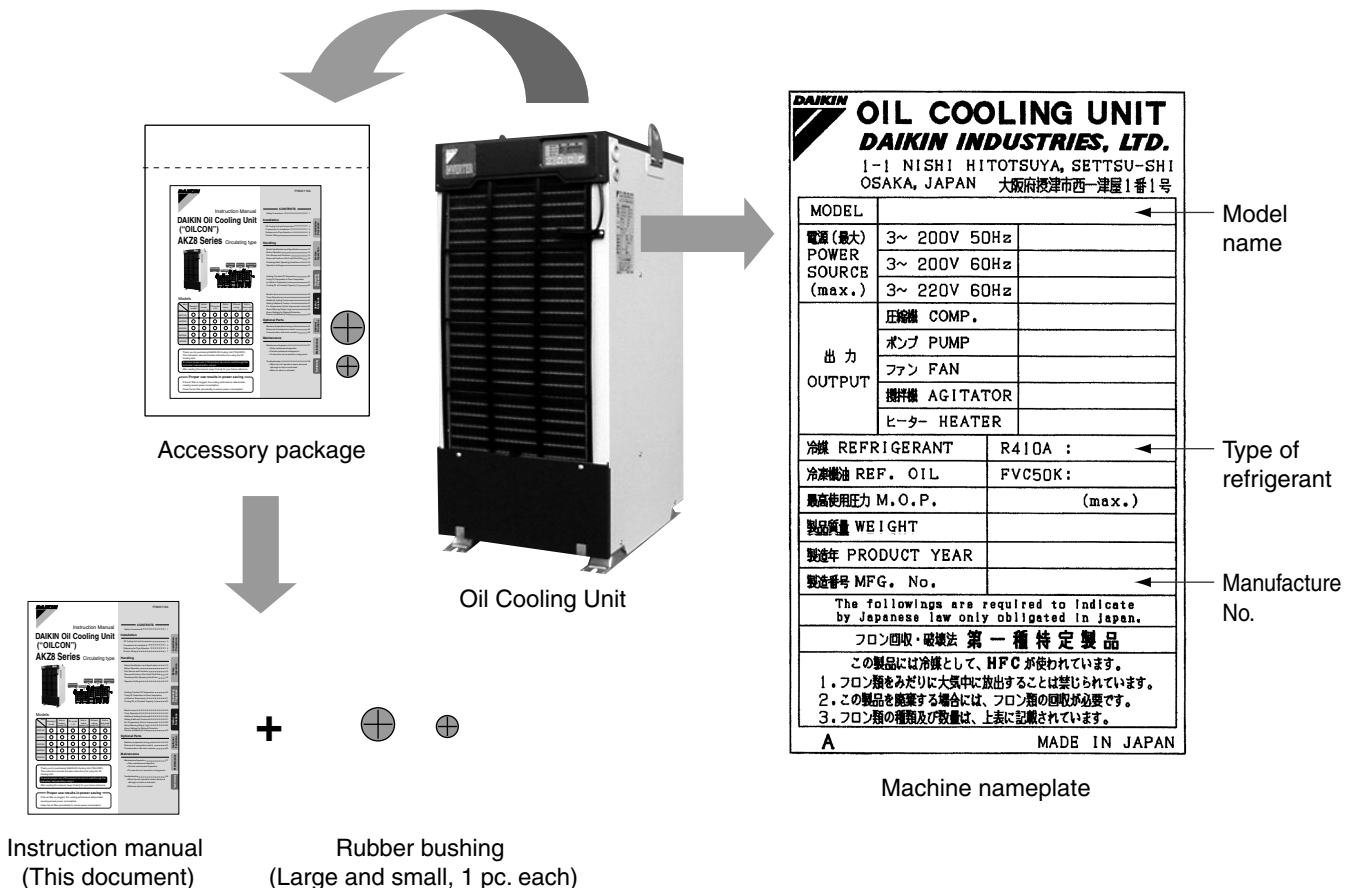

Precautions for Installation

Installation place and oil piping

- To install this unit, select a place that meets the following conditions:
 1. Level, rigid floor (Inclination: 5° max.)
 2. A place where the unit is not exposed to direct sunlight or heat
 3. A place with proper ventilation and little humidity
 4. A place where exhaust air does not circulate (exhaust air will not be taken into the unit)
 5. A place that allows easy access to piping and wiring
 6. A place with little contaminant, waste, dust particles or oil mist
 7. A place free from explosive atmosphere (evolution, inflow, retention or leak of inflammable gas)
- Do not place an object that may block air flow within 500 mm from the air intake/exhaust port.

Oil piping: Locations of the oil inlet, oil outlet and oil drain are shown below.

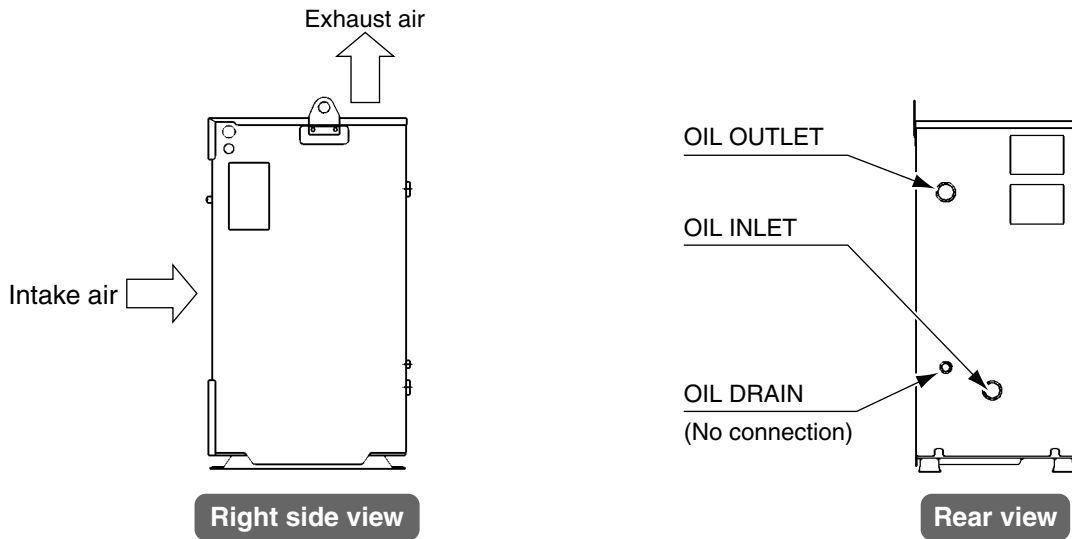

1. Make sure that the pressure loss at the oil inlet/outlet is within the following range:
 - Suction pressure (at oil inlet) -30.7 to 0 kPa
 - Discharge pressure (at oil outlet) 0.5 MPa or less
2. Avoid using a valve in the middle of the piping.
If a valve is used, it causes a large pressure loss even when it is fully opened.
3. If the oil viscosity is high, or if there is a large pressure loss in external piping (other than the piping for the Oil Cooling Unit), use a pipe with a larger diameter to reduce the pressure loss. (To change the pipe size, refer to “**Reference for Pipe Selection**” on page 6.)
If the operating condition exceeds the specified range, it causes noise or fault of the unit. Use thorough caution about the operating condition. Keep the oil viscosity at 1.4 to 200 mm²/s.
4. Wrap the pipe joints with sealing tape to prevent air entry or oil leak.
5. Make sure that the oil piping of the main machine is not blocked (fully closed).

Suction strainer (Line filter)

Attach a strainer (mesh size: 100 to 150) with a small pressure loss to the oil piping system.

- If the evaporator (cooler) in the Oil Cooling Unit is clogged with dust, it causes not only cooling capacity deterioration, but also a fault of the compressor or oil pump.
- During adjustment at trial run, the strainer gathers much dust from the oil piping system. Clean the strainer before starting actual operation. Check the strainer periodically.

Oil tank

- To receive oil from the main machine oil piping system, provide an oil tank that can accept an increase/decrease in oil quantity.
- Consider the tank structure so that inside of the tank can be easily cleaned. (For example, the tank top plate is detachable.)

Reference for Pipe Selection

Connection pipe diameter (Standard model)

Model	AKZ148	AKZ328/438	AKZ568/908
Oil Inlet	Rc3/4		Rc1 1/4
Oil Outlet	Rc3/4		Rc1 1/4
Oil Drain	Rc1/4		

* For menu models, refer to "Model Identification and Specifications" on page 12-13.

Pipe size/maximum pipe length chart

Suction pipe (Hose inner diameter)

Unit: m

Model	Size (mm)	φ19	φ25.4	φ31.8	φ38.1
AKZ148	50 Hz	2.1	6.3	(15)*1	—
	60 Hz	1.7	5.1	(12)*1	—
AKZ328 AKZ438	50 Hz	—	2.8	6.7	—
	60 Hz	—	2.3	5.5	—
AKZ568 AKZ908	50 Hz	—	—	5	10
	60 Hz	—	—	4	8

Discharge pipe

Unit: m

Model	Size (mm)	φ12.7	φ19	φ25.4	φ31.8
AKZ148	50 Hz	4.2	21	*2	—
	60 Hz	3.4	17	*2	—
AKZ328 AKZ438	50 Hz	1.8	9	28	—
	60 Hz	1.4	7	23	—
AKZ568 AKZ908	50 Hz	—	—	20	48
	60 Hz	—	—	16	40

Condition: ISO VG32, Viscosity: 200 mm²/s

*1: The above pipe size may not be applied to the unit, depending on the pipe specifications. For details, contact DAIKIN.

*2: Refer to the pipe resistance calculation formula.

Pipe resistance calculation method

To determine the oil pipe size, calculate it based on the following formula:

$$\Delta P = 0.595 \times V \times Q \times L/D^4$$

(For general hydraulic oil/lubrication oil)

ΔP: Pipe resistance (MPa)

V: Kinematic viscosity coefficient (mm²/s)

.....See "Viscosity vs. Temperature" chart.

Q: Flow rate (L/min)

L: Pipe length (m)

D: Pipe inner diameter (mm)

*For flow rate (Q), refer to "Oil pump discharge rate" in "Model Identification and Specifications" on page 12-13.

Example of viscosity (Kinematic viscosity coefficient)

(1) In winter: 195 mm²/s (ISO VG32, Oil temperature: 5°C)

(2) In summer: 29 mm²/s (ISO VG32, Oil temperature: 40°C)

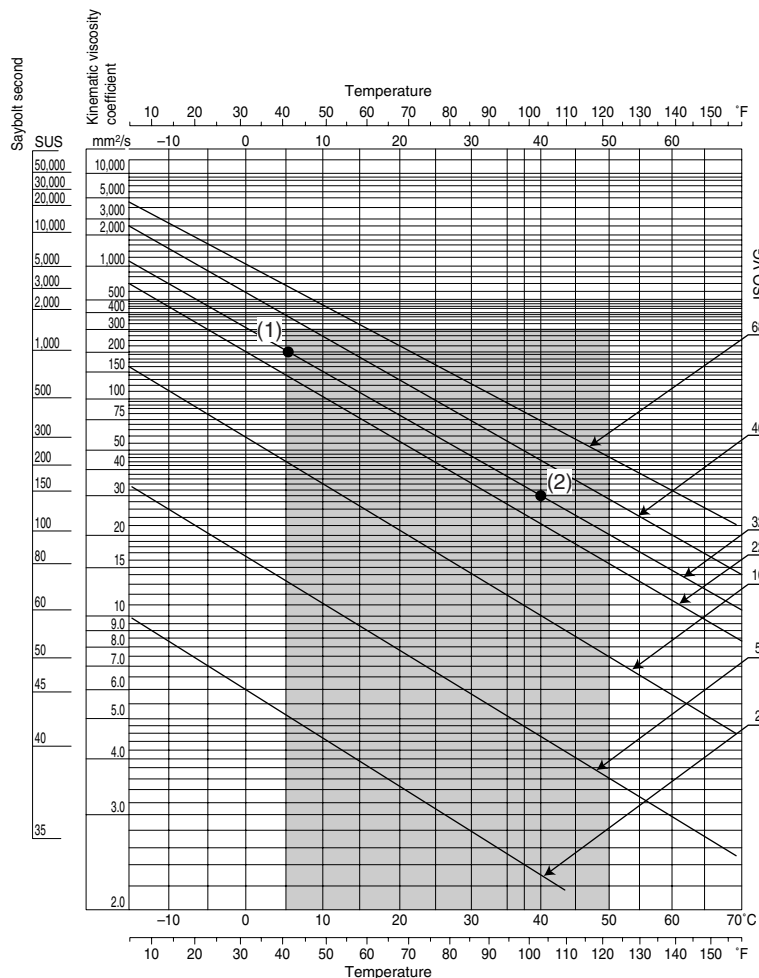

Electric Wiring

- Conduct electric wiring according to the local wiring standard.
- The Oil Cooling Unit (except for the “-B” model) is not equipped with a circuit breaker. A circuit breaker exclusively for the unit should be mounted to the main machine.
- For electric wiring, refer to the electric wiring diagram on the nameplate attached to the rear of the electrical equipment box cover.
- Do not change the wiring in the Oil Cooling Unit. Do not touch the protection devices.

Starting/stopping the Oil Cooling Unit

To turn ON the power supply for the Oil Cooling Unit, the following three methods are available:

1 Directly starting/stopping the Oil Cooling Unit with the main machine power supply

When the circuit breaker for the main machine is turned ON, the Oil Cooling Unit starts operation. To stop the unit, turn OFF the circuit breaker for the main machine.

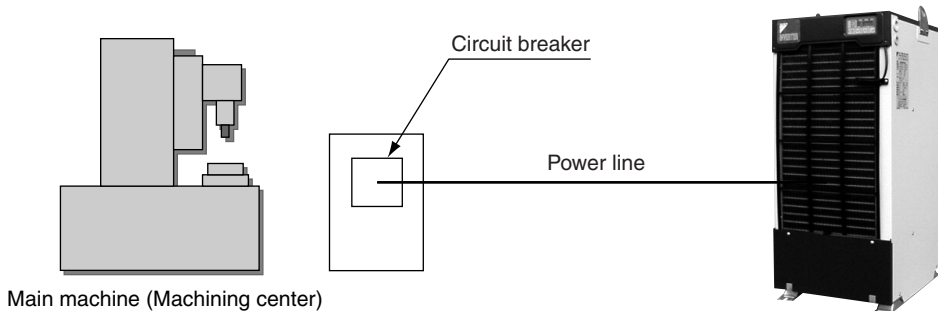



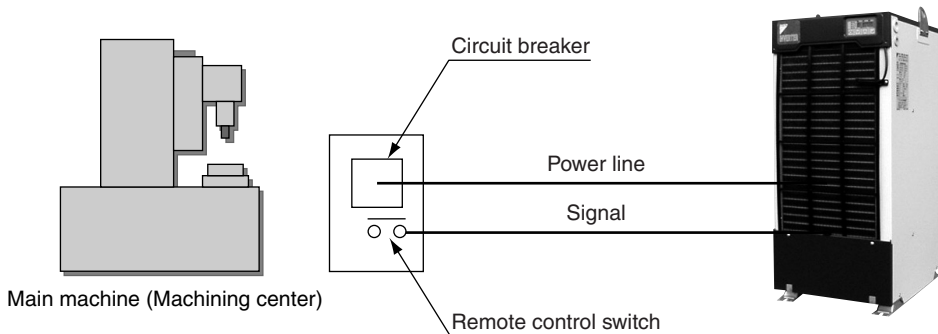

2 Starting/stopping the Oil Cooling Unit with the remote control contact (see page 9)

When the remote control switch is turned ON, the Oil Cooling Unit starts operation. To stop the unit, turn OFF the remote control switch.



3 Starting/stopping the Oil Cooling Unit with the control panel

If you keep pressing the  and  keys for at least 2 seconds in the “operation lock” mode, the Oil Cooling Unit starts operation according to preset conditions. If you keep pressing the  and  keys for at least 2 seconds during operation, “Loc” blinks on the data display, and the Oil Cooling Unit will be stopped (locked).

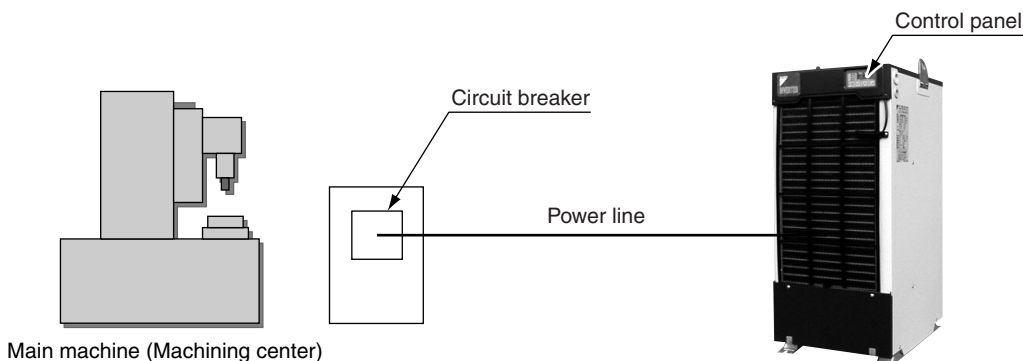

Mounting a circuit breaker

The Oil Cooling Unit is not equipped with a circuit breaker. Be sure to mount a 3-pole circuit breaker exclusively for the Oil Cooling Unit to the main machine. For the breaker capacity, refer to the specifications of each model (see page 12-13). To ensure safety, it is recommended to use an earth leakage breaker.

* Mount a circuit breaker exclusively for the Oil Cooling Unit.

CAUTION

To use an earth leakage breaker, select an inverter-compatible type. If the earth leakage breaker is not inverter-compatible, it may malfunction due to high-frequency noise of the inverter. (Recommended product: 15 mA or 20 mA)

Wiring procedure

1 Remove the top plate mounting screws, and remove the top plate.

2 1. Insert the power cable into the power cable insertion hole ($\phi 28$) in the side plate of the unit. When using the different-voltage model (-E), insert the power cable into the transformer box.
 2. Insert the remote control signal cable and external output signal cable into the signal cable insertion hole ($\phi 22$) in the side plate of the unit.
 * When inserting each cable from the left side of the unit (when viewed from the front of the unit), place the cable along the guide rail in the electrical equipment box. Then, fasten the cable to the cable anchor at the bottom of the electrical equipment box by using a tie band etc.

3 Connect the power cable to the power supply terminal block. Connect the ground cable to the PE (ground) terminal.

■ The cable size should conform to those listed below, or a larger size.

Cable type / Model/Series name	AKZ148/328/438/568 series	AKZ908 series
JIS	Heat-resistant vinyl, 2.0 mm ²	Heat-resistant vinyl, 3.5 mm ²
UL cable	UL1015 AWG#14 (equivalent to 2.0 mm ²)	UL1015 AWG#12 (equivalent to 3.3 mm ²)
IEC/CENELEC cable	2.5 mm ² (245 IEC53/H05RR-F)	4.0 mm ² (245 IEC53/H05RR-F)

- To connect each cable, use M4 (AKZ908: M5) shielded round crimp terminal.
- Place the power cable in a conduit.
- For **remote control input connecting** procedure, refer to page 9.
- For **external output contact connecting** procedure, refer to page 10.

4 Re-mount the top plate, and fasten it with the screws.

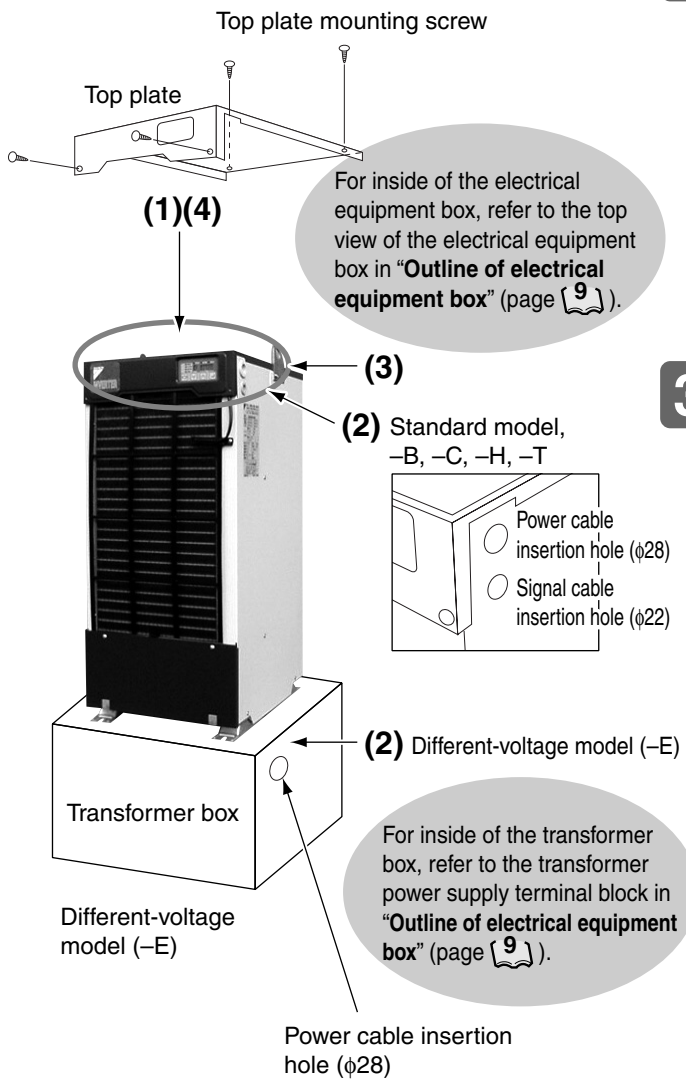

Outline of electrical equipment box (Typical)

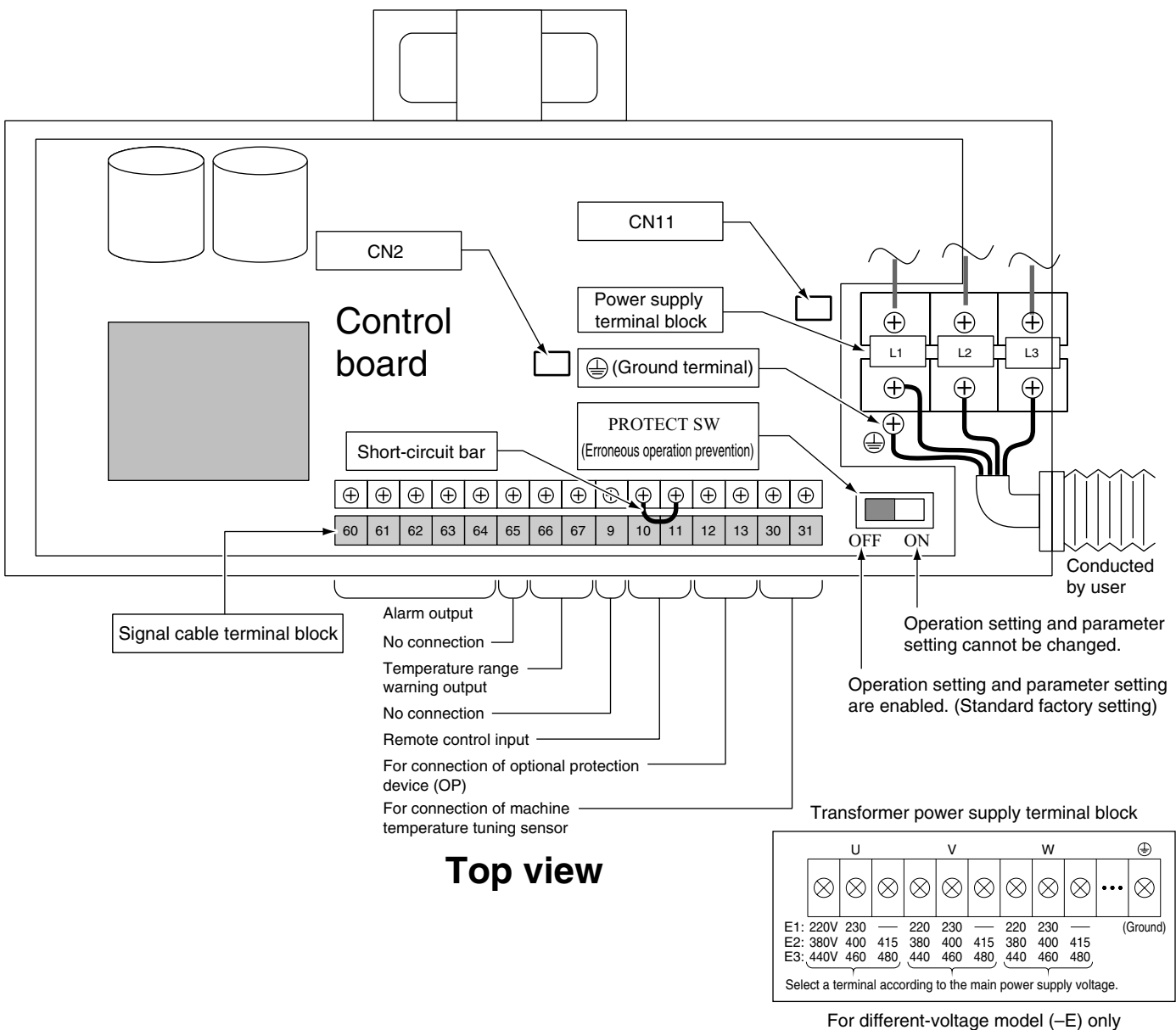

Connection of remote control input

To execute remote control, connect the cable according to the procedure below.

1 Local procurement items

Component	Single-pole, single-throw remote control switch, or “a” contact that enables operation command output (Note) Select a switch whose minimum allowable load is 12 VDC and 5 mA.
Wiring material	Single-core cable: $\phi 1.2$ (AWG16), or twisted cable: 1.25 mm ² (AWG16), M3 crimp terminal

2 Remove the short-circuit bar (between terminals [10] and [11]) on the terminal block in the electrical equipment box.

3 Connect the cable specified in **1** above between terminals [10] and [11].
*12 VDC is applied across these terminals (Terminal [10]: negative polarity, [11]: positive polarity).

Connection of external output contact

To output the Oil Cooling Unit operation status signal to the main machine, connect the required signal cable to the signal terminal block according to the procedure below. For details of alarms, refer to "Alarm list" (page 39-40). To use an output contact, change the parameter setting, and make sure that the output contact normally operates. (For parameter setting changing procedure, refer to page 26.)

1. Screw terminal and cable size
2. Connect each cable by using a round crimp terminal.
3. Use a twisted cable.
4. When a 2-core IEC cable is used, the cable size should be 0.5 to 1.5 mm².

Screw terminal	Cable size		
	JIS cable	IEC cable	UL cable
M3	0.25 mm ² - 1.25 mm ²	0.3 mm ² - 1.5 mm ²	AWG#22 - #16

1 External output circuit

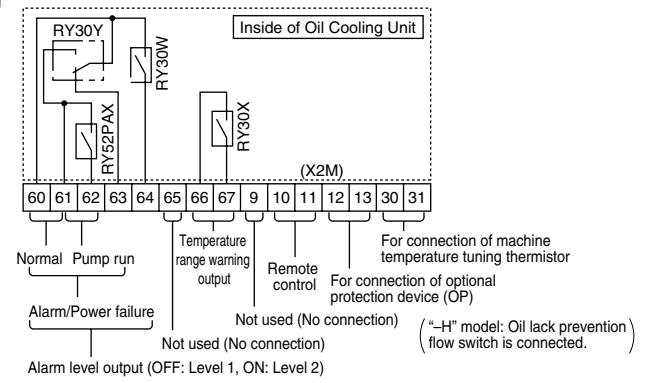

(For alarm levels, refer to page 39.)

2 Alarm output logic

The alarm output logic can be changed depending on the parameter setting. (See page 33.)

3 When the power supply is turned ON, external output becomes unstable.

Set up the main machine sequence program so that the external output signal is ignored for one second after power-ON.

⚠ CAUTION

- The contact capacity is as follows:
Resistance load: 30 VDC, 2 A
- The minimum allowable load is as follows:
10 μA, 10 mV
- To connect an inductive load, be sure to use a surge absorber.

Value of the first digit in alarm output logic parameter (n01)	
0 (Factory setting) [Positive action]	1 ["b" contact]
<p>Normal</p>	<p>Normal or power failure</p>
<p>Alarm or power failure</p>	<p>Alarm</p>

External output timing chart

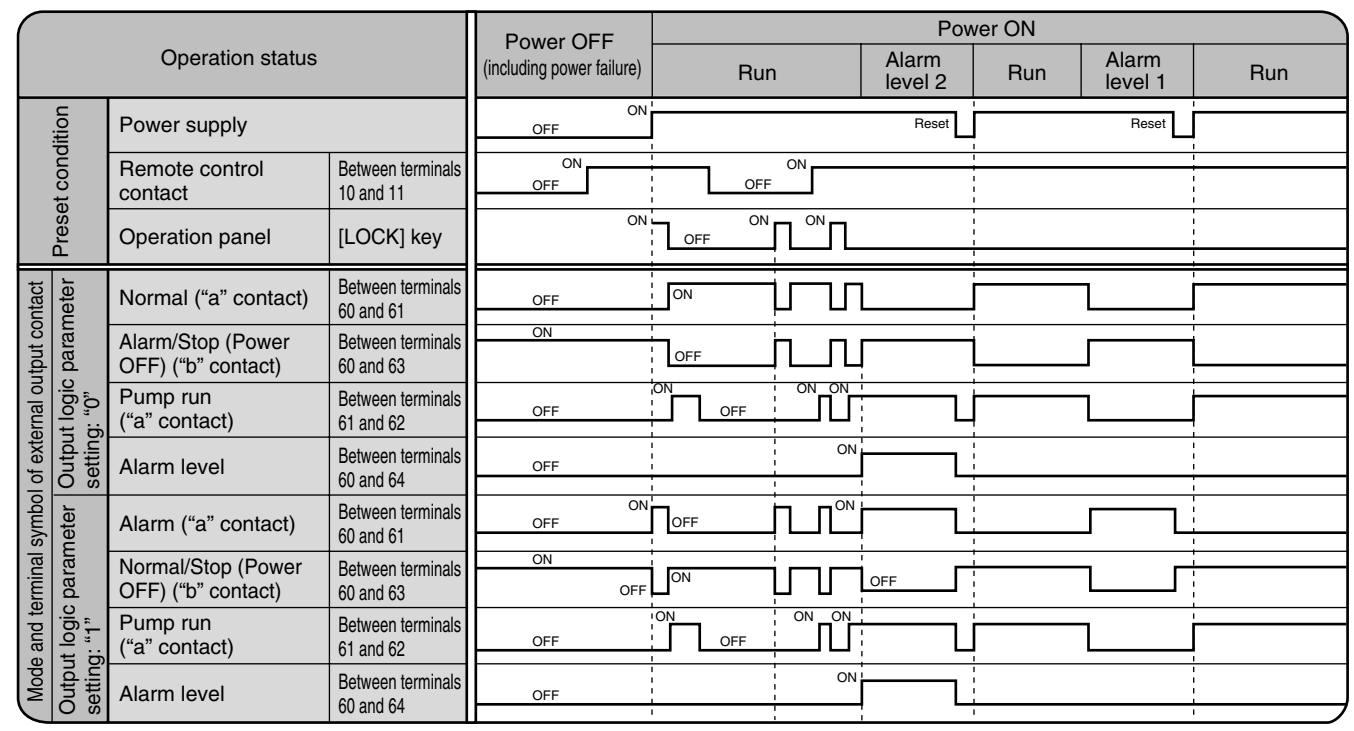

Electric wiring diagram (Typical: AKZ328)

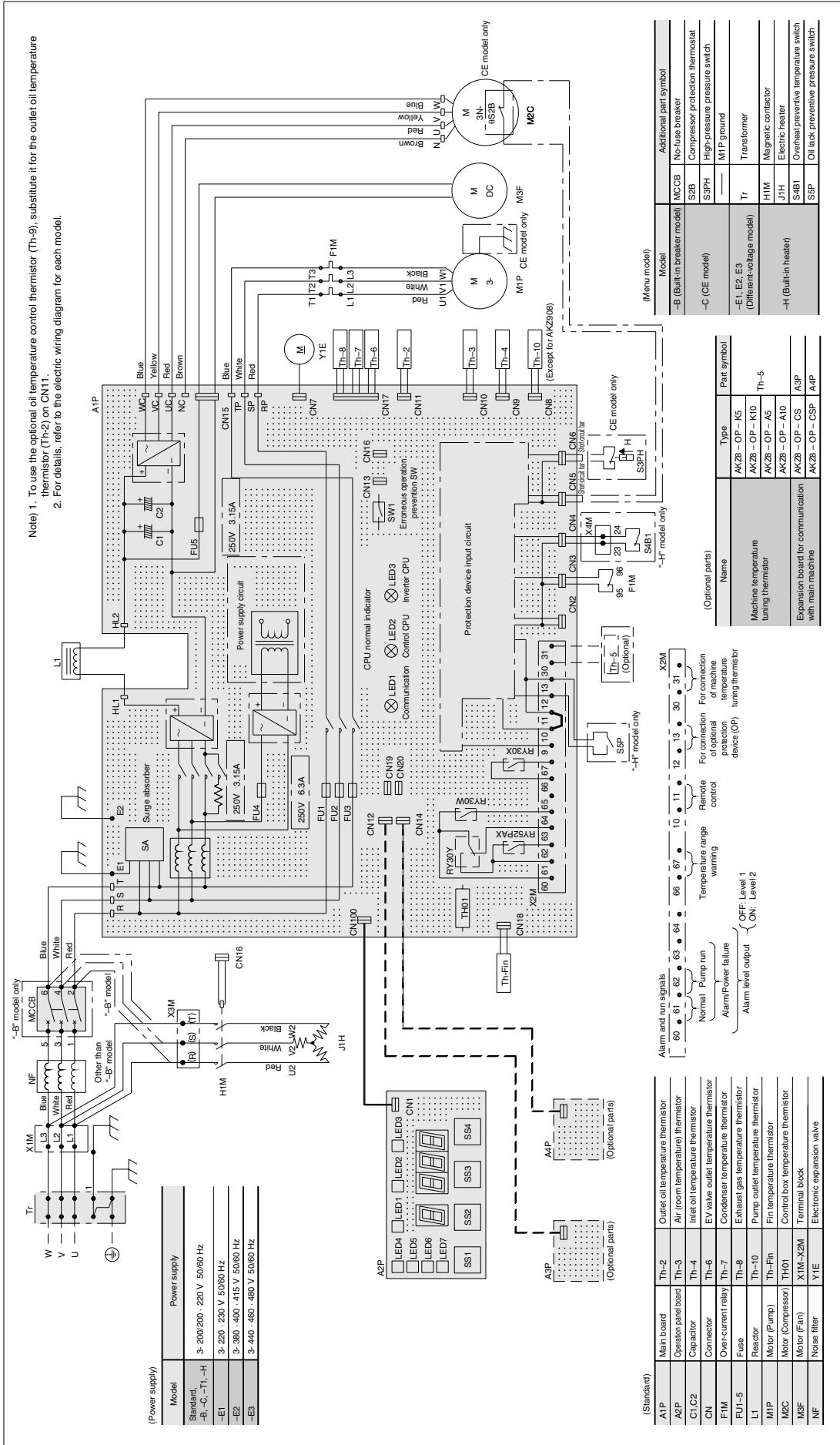

Model Identification and Specifications

Specifications (AKZ148/328/438)

Oil Cooling Unit equivalent horsepower (HP)		0.5					1.2					1.5							
Model		AKZ148					AKZ328					AKZ438							
		Stand-ard	-B	-C	-H	-T1	-E*3	Stand-ard	-B	-C	-H	-T1	-E*3	Stand-ard	-B	-C	-H	-T1	-E*3
Cooling capacity (50/60 Hz) ¹	kW	1.3/1.4					2.8/3.2					3.8/4.3							
Heater	kW	1					1					1							
Power supply ²		3-phase 200/200 · 220 VAC 50/60 Hz					3-phase 200/200 · 220 VAC 50/60 Hz					3-phase 200/200 · 220 VAC 50/60 Hz							
Circuit voltage	Main circuit	3-phase 200/200 · 220 VAC 50/60 Hz																	
	Operation circuit	12/24 VDC																	
Max. power consumption Max. current consumption	200 V 50 Hz	1.20 kVA/3.5 A					1.70 kVA/5.3 A					2.31 kVA/6.6 A							
	200 V 60 Hz	1.32 kVA/3.7 A					1.73 kVA/5.5 A					2.35 kVA/6.8 A							
	220 V 60 Hz	1.33 kVA/3.9 A					1.75 kVA/5.7 A					2.45 kVA/7.0 A							
Transformer capacity		2.6 kVA					2.6 kVA					2.6 kVA							
Exterior color		White																	
Outer dimensions (H × W × D)	mm	650 × 360 × 440	950 × 360 × 440	820 × 360 × 465	950 × 360 × 440	790 × 360 × 440	1090 × 360 × 440	1055 × 360 × 465	1090 × 360 × 440	990 × 360 × 440	1290 × 360 × 440	1225 × 360 × 465	1290 × 360 × 440						
Compressor (Fully-enclosed DC swing type)		Equivalent to 0.4 kW					Equivalent to 0.75 kW					Equivalent to 1.1 kW							
Evaporator		Shell & coil type																	
Condenser		Cross fin coil type																	
Propeller fan	Motor	φ300, 75 W																	
Oil pump	Motor	0.4 kW × 4P																	
	Discharge rate L/min	12/14.4					24/28.8					24/28.8							
	Clacking pressure MPa	0.6																	
Temperature control (Selectable)	Tuning type	Reference	Room temperature or machine temperature ⁴ (Factory setting: Room temperature: Mode 3)																
		Control target	Inlet oil temperature or outlet oil temperature (Factory setting: Inlet oil temperature)																
		Tuning range K	Within ±9.9 relative to reference temperature (Factory setting: 0.0)																
	Fixed type	Control target	Inlet oil temperature or outlet oil temperature																
Range °C		5-50																	
Refrigerant control		Inverter compressor rotation speed + Electronic expansion valve opening																	
Refrigerant (New refrigerant: R410A) ⁵ Loading weight	kg	0.49					0.72					0.98							
Protection device		Over-current relay (Pump motor), Reverse-phase protector, Restart prevention timer, Low room temperature protection thermostat, High oil temperature protection thermostat, Low oil temperature protection thermostat, Pump relief valve, Discharge pipe temperature thermostat, Condenser temperature thermostat, Refrigerant leak detector, Inverter protector, High-pressure pressure switch ("C" only), Compressor protection thermostat ("C" only), Overheat prevention temperature thermostat ("H" only), Oil lack prevention switch ("H" only)																	
Operating range	Room temperature °C	5-45																	
	Inlet oil temperature °C	5-50																	
	Oil viscosity mm ² /s	1.4-200 (ISO VG2-32)																	
	External pressure loss	Discharge	0.5 MPa or less																
		Suction	Within -30.7 kPa																
Applicable oil		Lubrication oil, Mineral hydraulic oil (Phosphoric ester hydraulic oil, water/water-soluble liquid, chemical, food, fuel, cutting/grinding fluid cannot be used.)																	
Connection pipe	Oil inlet	Rc3/4																	
	Oil outlet	Rc3/4	Rc1 1/4	Rc3/4					Rc1 1/4	Rc3/4					Rc1 1/4	Rc3/4			
	Oil drain	Rc1/4 (Fastened with plug)																	
Sound level (Measured at 1 m from front of unit, at 1 m height, in anechoic room)	dB (A)	62										65							
Transportation vibration resistance		Vertical: 14.7 m/s ² (1.5 G) × 2.5 hr (10 to 100 Hz sweep/5 min)																	
Weight	kg	52	62	67	110	58	68	73	116	67	77	82	125						
Internal circuit breaker (Rated current)	A	10					10					10							
Oil tank (Volume)	L	15					20					20							
Local procurement item	Circuit breaker (Rated current) A	10 (Required for the models other than "B")																	

Model identification

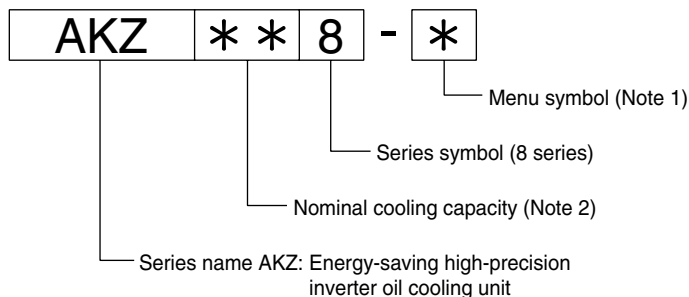

(Note 1) Menu symbol

- B : Circuit breaker (with built-in breaker)
- C : CE-conformable
- H : Built-in heater
- T : Built-in tank
- E : Different voltage (Built-in transformer)

E1 : 220 VAC, 230 VAC 50/60 Hz
 E2 : 380 VAC, 400 VAC, 415 VAC 50/60 Hz
 E3 : 440 VAC, 460 VAC, 480 VAC 50/60 Hz

(Note 2) Nominal cooling capacity

Indicates cooling capacity at standard point with commercial power supply frequency of 60 Hz. (Inlet oil temperature and room temperature: 35°C, VG32-equivalent oil is used.)

- 14 : 1.4 kW
- 32 : 3.2 kW
- 43 : 4.3 kW
- 56 : 5.6 kW
- 90 : 9.0 kW

Specifications (AKZ568/908)

Oil Cooling Unit equivalent horsepower (HP)		2.0					3.0									
Model		AKZ568					AKZ908									
		Stand-ard	-B	-C	-H	-T	-E ^{*3}	Stand-ard	-B	-C	-H	-T	-E ^{*3}			
Cooling capacity (50/60 Hz) ^{*1}	kW				5.0/5.6						8.0/9.0					
Heater	kW		—		2		—		—		3		—			
Power supply ^{*2}		3-phase 200/200 · 220 VAC 50/60 Hz					3-phase 200/200 · 220 VAC 50/60 Hz					^{*3}				
Circuit voltage	Main circuit	3-phase 200/200 · 220 VAC 50/60 Hz														
	Operation circuit	12/24 VDC														
Max. power consumption	200 V 50 Hz	3.21 kVA/9.4 A					5.02 kVA/15.2 A									
Max. current consumption	200 V 60 Hz	3.30 kVA/9.5 A					5.14 kVA/15.6 A									
	220 V 60 Hz	3.34 kVA/9.2 A					5.20 kVA/14.5 A									
Transformer capacity					—		5 kVA				—		6 kVA			
Exterior color		White														
Outer dimensions (H × W × D)	mm	1110 × 470 × 560	1410 × 470 × 560	1375 × 470 × 580	1360 × 470 × 590	1220 × 560 × 620	1520 × 560 × 680	1485 × 560 × 700	1470 × 560 × 695							
Compressor (Fully-enclosed DC swing type)		Equivalent to 1.5 kW					Equivalent to 2.2 kW									
Evaporator		Shell & coil type														
Condenser		Cross fin coil type														
Propeller fan	Motor	φ400, 90 W × 4P					φ450, 150 W × 4P									
Oil pump	Motor	0.75 kW × 4P														
	Discharge rate	L/min 30/36														
	Clacking pressure	MPa 0.6														
Temperature control (Selectable)	Tuning type	Reference	Room temperature or machine temperature ^{*4} (Factory setting: Room temperature: Mode 3)													
		Control target	Inlet oil temperature or outlet oil temperature (Factory setting: Inlet oil temperature)													
		Tuning range	K Within ±9.9 relative to reference temperature (Factory setting: 0.0)													
	Fixed type	Control target	Inlet oil temperature or outlet oil temperature													
Range		°C 5–50														
Refrigerant control		Inverter compressor rotation speed + Electronic expansion valve opening														
Refrigerant (New refrigerant: R410A) ^{*5} Loading weight	kg	1.25					1.53									
Protection device		Over-current relay (Pump motor), Reverse-phase protector, Restart prevention timer, Low room temperature protection thermostat, High oil temperature protection thermostat, Low oil temperature protection thermostat, Pump relief valve, Discharge pipe temperature thermostat, Condenser temperature thermostat, Refrigerant leak detector, Inverter protector, High-pressure pressure switch (“-C” only), Compressor protection thermostat (“-C” only), Overheat prevention temperature thermostat (“-H” only), Oil lock prevention switch (“-H” only)														
Operating range	Room temperature	°C 5–45														
	Inlet oil temperature	°C 5–50														
	Oil viscosity	mm ² /s 1.4–200 (ISO VG2–32)														
	External pressure loss	Discharge	0.5 MPa or less													
Suction		Within -30.7 kPa														
Applicable oil		Lubrication oil, Mineral hydraulic oil (Phosphoric ester hydraulic oil, water/water-soluble liquid, chemical, food, fuel, cutting/grinding fluid cannot be used.)														
Connection pipe	Oil inlet		Rc 11/4		Rc 1		Rc 11/4		Rc 11/4		Rc 1		Rc 11/4			
	Oil outlet						Rc 11/4									
	Oil drain						Rc1/4 (Fastened with plug)									
Sound level (Measured at 1 m from front of unit, at 1 m height, in anechoic room)	dB (A)			65							67					
Transportation vibration resistance		Vertical: 14.7 m/s ² (1.5 G) × 2.5 hr (10 to 100 Hz sweep/5 min)														
Weight	kg	97		115		130		182		125		150		160		210
Internal circuit breaker (Rated current)	A	—	15			—			—	20				—		
Oil tank (Volume)	L			—		50		—					70		—	
Local procurement item	Circuit breaker (Rated current)	A	15 (Required for the models other than “-B”)					20 (Required for the models other than “-B”)								

Note) *1: Cooling capacity is the value at standard point (inlet oil temperature and room temperature: 35°C, ISO VG32 oil). The product tolerance is approx. ±5%.

*2: Be sure to use a commercial power supply. Using an inverter power supply may result in burnout. Voltage fluctuation range should be within ±10%.

If voltage fluctuation exceeds ±10%, consult DAIKIN.

*3: For the different-voltage model, three types (-E1, -E2 and -E3) are available depending on the power supply voltage.

*4: The optional machine temperature tuning thermistor is required. (For details, see page 34.)

*5: The “-C” model is supplied with MSDS (Material Safety Data Sheet) for refrigerant R410A.

*6: This product is not equipped with a circuit breaker. The user must prepare a circuit breaker.

*7: Conventional “1 HP”-equivalent models (AKS105AK/AKZ(S)257 class) have been integrated into AKZ328 (“1.2 HP”-equivalent).

Before Operation

Before operating the Oil Cooling Unit, check the following items:

1 Operating environment

- Check the atmosphere for any factor (dust, oil mist, high temperature, high humidity, etc.) that may adversely affect the unit.
- Check if the unit is not installed in explosive atmosphere (that may cause evolution, inflow, retention or leak of inflammable gas).
- The operating range is limited. Make sure that the operating conditions are within the following range.
(Note: If this unit is operated out of the specified range, the protection devices may be activated, or the service life may be shortened.)

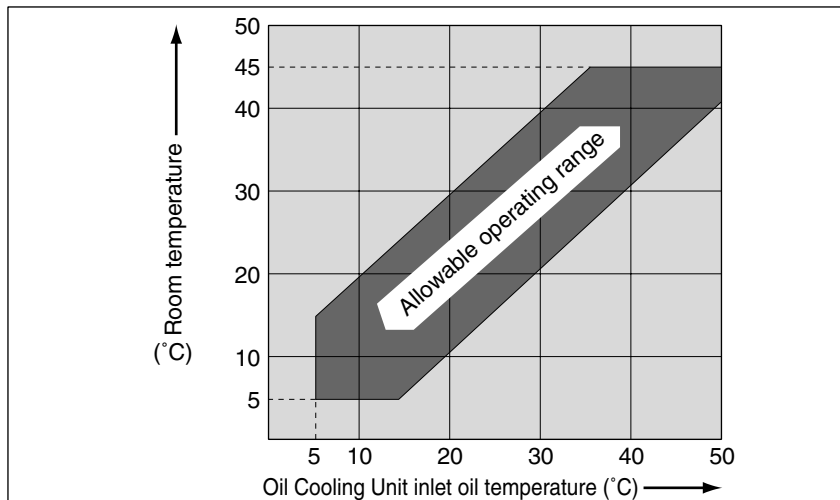

2 Installation

- Check if the unit has been securely fastened with bolts or foundation bolts.
- Check for any obstacle that blocks air intake or exhaust flow.
(Do not put an obstacle within 500 mm from the air intake/exhaust port.)

3 Oil piping

- Check the oil piping for leak.
- Check if an appropriate quantity of oil is filled in the tank. (Never run the pump without oil. Otherwise, the oil pump may be damaged.)
- Check if the main machine oil piping is not blocked (fully closed). (If the unit is operated with the main machine oil piping blocked (fully closed), the oil temperature rises, causing an alarm.)
- Check if the pressure loss is within the specified range. (Refer to “**Precautions for Installation**” on page { 5 }.)
- Check if the main machine oil piping is equipped with a flow switch.
(To protect the main machine, it is recommended to mount a flow switch.)

4 Applicable oil

- The Oil Cooling Unit is intended for lubrication oil and hydraulic oil (mineral oil). (Oils that belong to Class 3 petroleum and Class 4 petroleum among Class 4 dangerous substances prescribed by the Fire Service Law, and correspond to Discoloration No. 1 under “Petroleum Products—Corrosiveness to Copper—Copper Strip Test (JIS K2513)” and the pollution degree of NAS Class 10.) The following oils (liquids) cannot be used for this unit.
 1. Flame-resistant hydraulic oil (Phosphoric ester / chlorinated hydrocarbon / water + glycol / W/O, O/W emulsion type oils)
 2. Water and water-soluble liquids
 3. Chemical and food liquids
 4. Cutting oil (fluid) and grinding oil (fluid)
 5. Fuels (kerosene, gasoline, etc.)

 **CAUTION**

 Before operating the Oil Cooling Unit, be sure to read through this instruction manual and understand the contents of this manual.

5 Electric wiring

- Check if the cable size is larger than the specified size. (Refer to “**Wiring procedure**” on page { 8 }.)
- Check if the ground cable is securely connected.
- Be sure to use a commercial power supply. Using an inverter power supply may result in burnout.
- Check if the power supply voltage is within the following range:
 - 50 Hz.....200 V ±10%
 - 60 Hz.....200/220 V ±10%
- Check if a circuit breaker is provided exclusively for each Oil Cooling Unit.

Part Names and Functions

Standard (-B, -C)

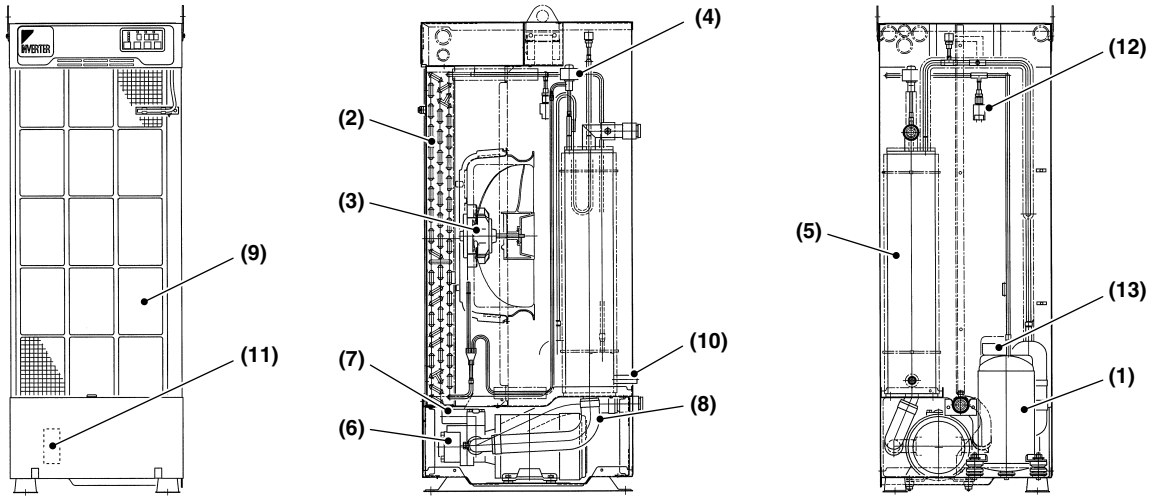

-H

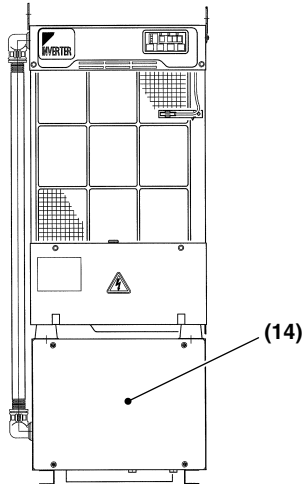

-E

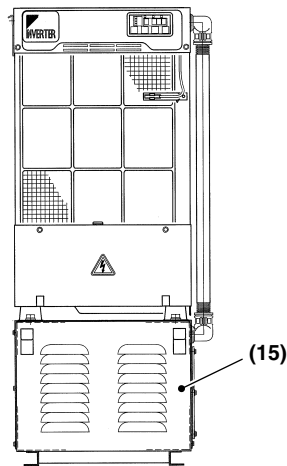

-T1, -T

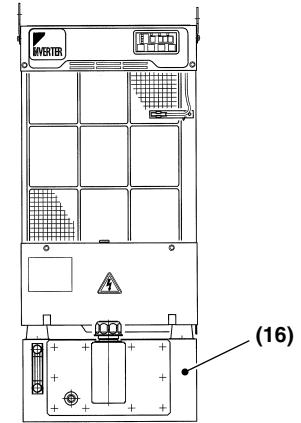

Handling

Before Operation

No.	Name	Function	No.	Name	Function
(1)	Compressor	Sucks and compresses the low-temperature, low-pressure gas refrigerant produced in the evaporator, to produce high-temperature, high-pressure gas.	(9)	Air filter	Located at the front of the condenser. It is intended to prevent cooling capacity deterioration by eliminating dust adhering to the condenser from the air intake.
(2)	Condenser	Conducts heat exchange between the high-temperature, high-pressure gas refrigerant produced in the compressor and the air, to produce high-temperature, high-pressure liquid refrigerant.	(10)	Oil drain	Drains oil from the evaporator when the Oil Cooling Unit is re-located.
(3)	Fan (for condenser)	Forcefully blows air to accelerate heat exchange between the refrigerant in the condenser and the air.	(11)	Circuit breaker ("B" only)	Tripped when over-current flows through the circuit. It is intended to protect the internal electric wiring.
(4)	Electronic expansion valve	The valve mechanism reduces pressure of the high-temperature, high-pressure liquid refrigerant produced in the condenser, to produce low-temperature, low-pressure liquid/gas mixed refrigerant.	(12)	High-pressure pressure switch ("C" only)	Tripped when high-pressure alarm is activated. It is intended to protect the refrigerant system for the condenser etc.
(5)	Evaporator	Evaporates the low-temperature, low-pressure liquid refrigerant produced in the electronic expansion valve by conducting heat exchange between the refrigerant and oil, to produce low-temperature, low-pressure gas refrigerant.	(13)	Compressor protection thermostat ("C" only)	Tripped when compressor head high-temperature alarm is activated. It is intended to protect the compressor.
(6)	Oil pump	Sucks oil from outside of the unit, and discharges it from the unit through the evaporator.	(14)	Heater ("-H" only)	During warm-up in winter, the electric heater heats up the oil to a preset temperature.
(7)	Relief valve	Limits the oil pump discharge pressure within a specified level.	(15)	Transformer ("-E" only)	Intended for the different-voltage model.
(8)	Rubber hose	A part of the oil piping for suction and discharge of the oil pump.	(16)	Oil tank ("-T1" and "-T" only)	Receives oil from the main machine oil piping system. The oil tank can accept an increase/decrease in oil quantity.

Names and Functions of the Control Panel Parts

Outline of control panel

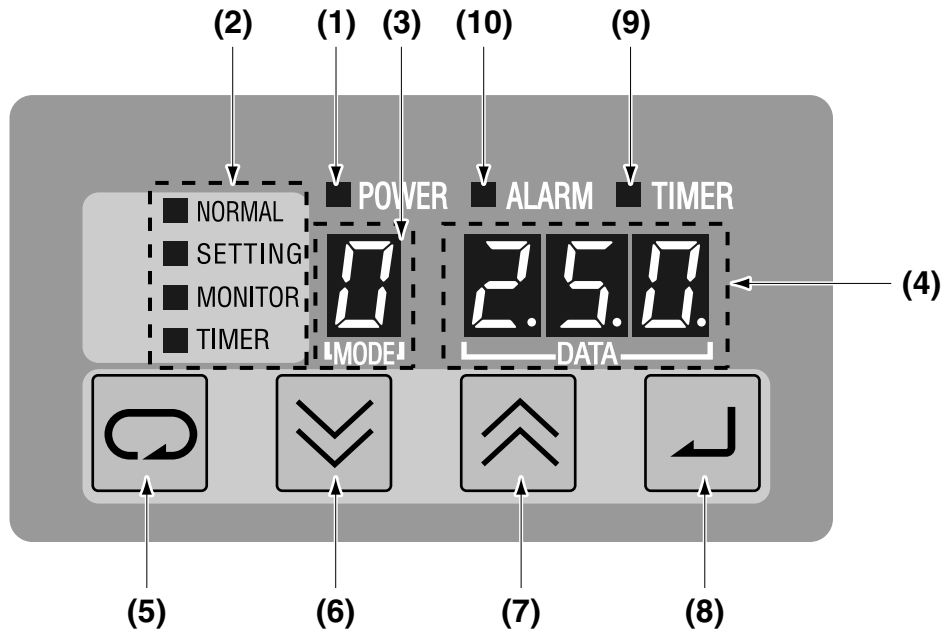

No.	Name	Description	Reference page
(1)	Power lamp (Green)	Lit while power supply is ON.	
(2)	Operation mode indicator	Indicates the control panel operation mode. NORMAL : Normal mode SETTING : Operation setting mode MONITOR : Monitor mode TIMER : Timer setting mode	page 17
(3)	Operation mode/data number display	Display the current operation mode (NORMAL/SETTING), or the data number currently displayed on the data display.	
(4)	Data display	Displays various data. The displayed data vary depending on the operation mode and data number.	
(5)	[SELECT] (selection) key	Used to select each mode.	
(6)	[DOWN] key	Decrements the number of operation mode or data number/value by one. If you keep pressing this key, the number is decremented by ten.	
(7)	[UP] key	Increments the number of operation mode or data number/value by one. If you keep pressing this key, the number is incremented by ten.	
(8)	[ENTER] (registration) key	Registers an operation mode, data number or data changed.	
(9)	Timer mode lamp (Red)	Blinks while the unit is halted in the timer mode.	page 24
(10)	Alarm lamp (Red)	When an alarm is activated: Blinks (Operation stops).....Alarm level 1 Lit (Only the compressor stops).....Alarm level 2	page 39

Operation mode

The control panel provides the following seven operation modes. Among these seven modes, only four modes are available for normal operations. In other modes, the Oil Cooling Unit may malfunction depending on operation. Before using each mode, please understand the description on each mode.

	Mode	Description	Operation mode indicator	Reference page
	Operation lock mode	Disables operations of the Oil Cooling Unit regardless of preset conditions.		page 18
○*1	Normal mode	Displays the current operation mode and control target value.	“NORMAL” lamp is lit.	page 18
○*1	Operation setting mode	Specifies an operation mode and control target value.	“SETTING” lamp is lit.	page 19-22
○*1	Monitor mode	Displays the current value of each thermistor etc.	“MONITOR” lamp is lit.	page 23
○*1	Timer setting mode	Used to set up time for the ON timer.	“TIMER” lamp is lit.	page 24
	Parameter setting mode	Used to set up basic parameters*2 of the Oil Cooling Unit.	“SETTING” lamp blinks.	page 25
	Auto-tuning mode	Used to set up the function for control response improvement.	“NORMAL” lamp blinks.	page 30

*1: The operation modes marked with a circle can be used for normal operation.
 *2: “Parameter” means a constant to be defined for each setting.

Mode changing operation

Normally, the  key is used to shift between individual modes.

For special modes, you can change the mode by pressing several keys simultaneously for two seconds.

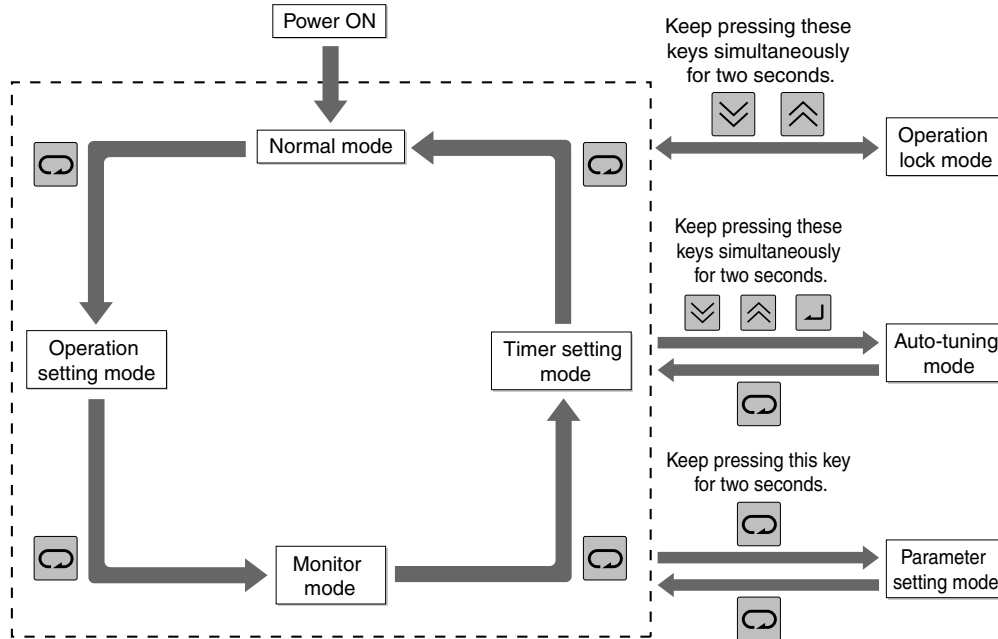

⚠ CAUTION

- 

 ■ The factory setting is the “Operation lock” mode. To start operation, cancel the operation lock mode. (See page 18.)
- With the standard model, the initial operating conditions are as follows:
 Operation mode: 3 (Room temperature tuning, Inlet oil temperature control)
 Temperature difference: 0.0 (K)

Checking Initial Operating Conditions

Before Operation Handling

Turn ON the power supply for the Oil Cooling Unit.
Check the indication on the control panel.

*1: You hear tick sound after power-ON, while the electronic expansion valve is under initial setup. This does not mean a fault.
*2: For initial setup of the electronic expansion valve and the microprocessor, the Oil Cooling Unit takes 60 to 90 seconds. After the initial setup, cooling operation starts (the compressor runs).

Is "U1" displayed on the control panel?

YES

It means reverse-phase connection. Exchange two phases out of three phases (L1, L2 and L3).



NO

Is the "Operation lock" mode selected?
The DAIKIN factory setting is the "Operation lock" mode.

YES

Cancel the operation lock mode.

* The "Operation lock" mode locks the Oil Cooling Unit, and disables any key operation other than operation lock cancel.

If you keep pressing the  and  keys simultaneously for two seconds, the Oil Cooling Unit starts operation.

NO

Operation lock mode

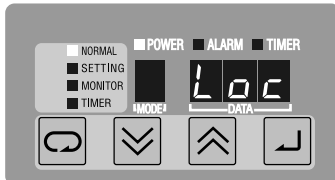

Keep pressing these keys simultaneously for two seconds.

Normal mode

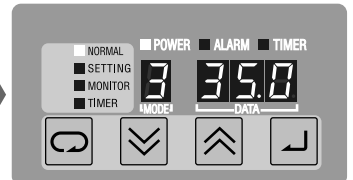

Check the initial operating conditions.

Check the current operation settings on the control panel display.

With the standard model, the factory setting of the operation mode is "3" (Room temperature tuning, Inlet oil temperature control), and the temperature difference is "0.0 (K)". (With non-standard models, the factory settings may be different from the above.)

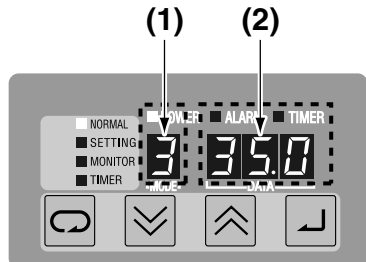

Example) Room temperature: 35°C

(1) **Operation mode display:** Displays the operation mode.

(2) **Data display:** Displays the target temperature setting.

See page  19 

Changing operation settings

Holding constant oil temperature _____

See page  20 

Tuning oil temperature to room temperature (or machine temperature) _____

See page  21 

Cooling oil at constant capacity (%) _____

See page  22 

Operation Setting

The Oil Cooling Unit operation setting provides the following modes.

	Control method	Reference temperature	Control target* ¹	Operation mode* ³ (Reference page)	Setting range	
Holding constant oil temperature (Keeping a control target at a constant temperature)	Fixed temperature control		Inlet oil temperature	0 (p. 20)	5.0–50.0 (°C)	
			Outlet oil temperature	1 (p. 20)	5.0–50.0 (°C)	
			Returned oil temperature* ²	1 (p. 20)	5.0–50.0 (°C)	
Tuning oil temperature to room temperature (or machine temperature) (Keeping a constant temperature difference between the control target and the reference temperature)	Tuning temperature control	Room temperature	Inlet oil temperature	3 (p. 21)	-9.9–9.9 (K) } * ⁴	
			Outlet oil temperature	5 (p. 21)		
			Returned oil temperature* ²	5 (p. 21)		
		Machine temperature* ²	Inlet oil temperature	4 (p. 21)		-9.9–9.9 (K)
			Outlet oil temperature	6 (p. 21)		-9.9–9.9 (K)
			Returned oil temperature* ²	6 (p. 21)		-9.9–9.9 (K)
Cooling oil at constant capacity (%) (Executes cooling operation according to capacity command, but disables oil temperature control.)	Capacity direct designation (used for trial run etc.)	None	None	9 (p. 22)	0–100 (%)	

*1: For control target measuring points, see the figure below.

*2: Optional function using optional parts

*3: Operation modes 2, 7 and 8 cannot be used.

*4: K (Kelvin) is a symbol of the SI unit system that indicates a temperature difference (°C).

System outline drawing

The oil cooling system of the Oil Cooling Unit is as shown below.

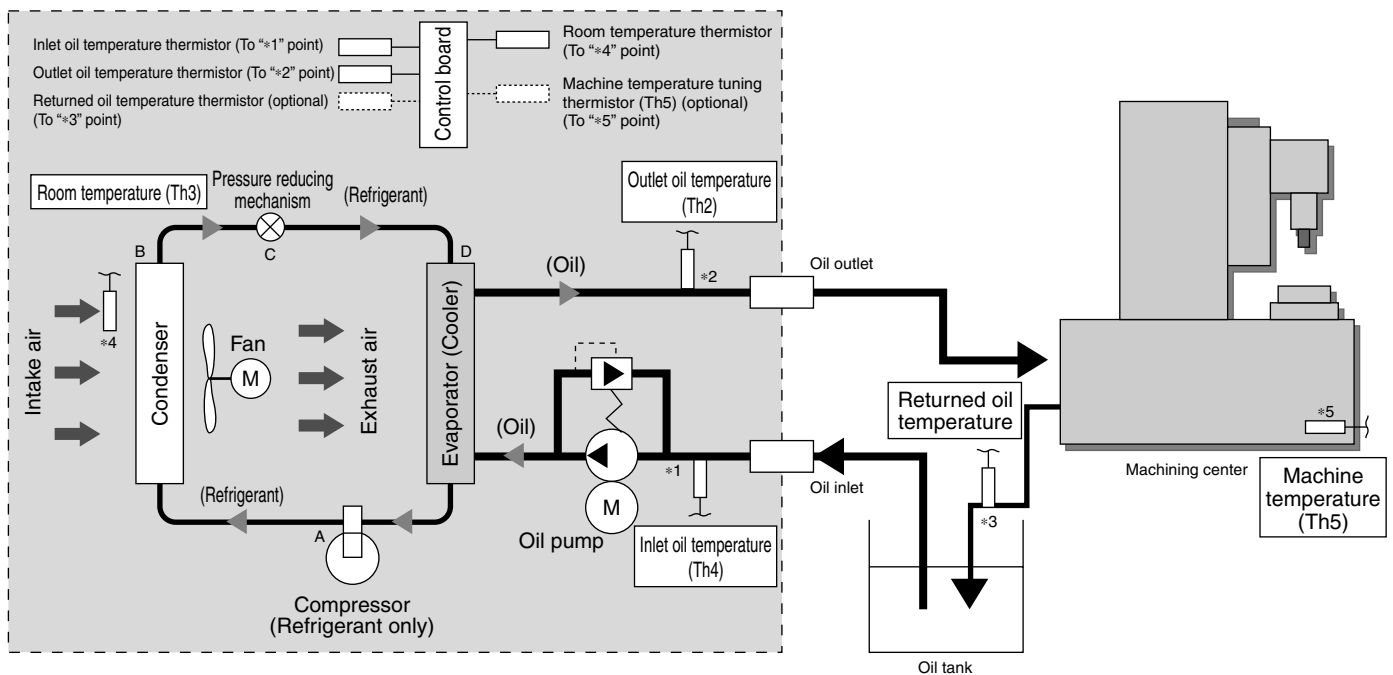

Description on the refrigerating cycle

- A: The compressor produces high-temperature, high-pressure compressed gas so that the refrigerant gas can be easily cooled and liquefied in the condenser.
- B: The condenser cools and condenses the high-temperature, high-pressure gas produced in the compressor, to transform it to high-temperature, high-pressure liquid.
- C: The pressure reducing mechanism throttles the high-temperature, high-pressure liquid to reduce pressure, and transform it to low-temperature, low-pressure liquid/gas mixture so that it can be easily evaporated in the evaporator.
- D: The evaporator evaporates the low-temperature, low-pressure liquid/gas mixture produced in the pressure reducing mechanism by absorbing heat from the oil (by cooling the oil), and transforms it to low-temperature, low-pressure gas.

Holding Constant Oil Temperature

To hold a constant oil temperature, the following two types of operation settings are available.

Controlling **the inlet oil temperature** at a constant temperature → Operation mode: 0

Controlling **the outlet (returned) oil temperature** at a constant temperature → Operation mode: 1

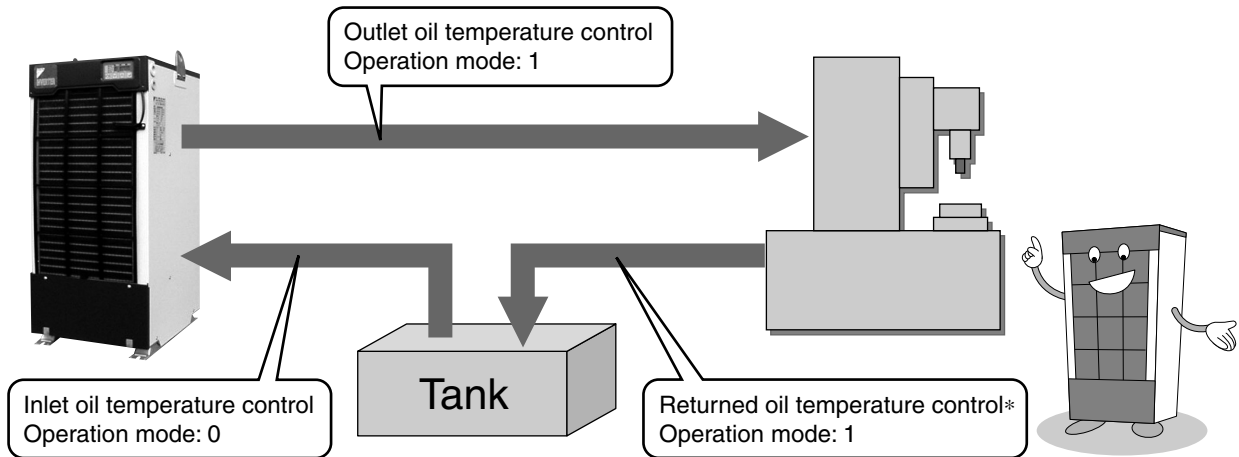

* Optional function using optional parts. See page 35.

Setting procedure

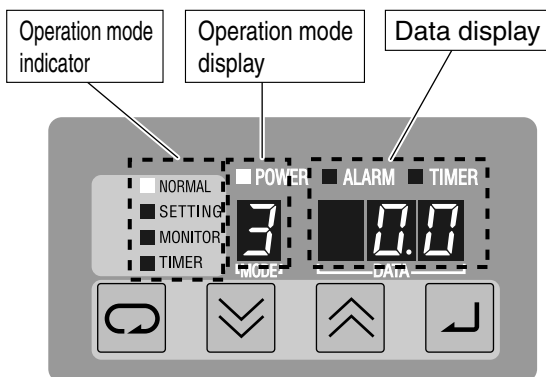

Factory setting
(With non-standard models, the settings may be different from the above.)

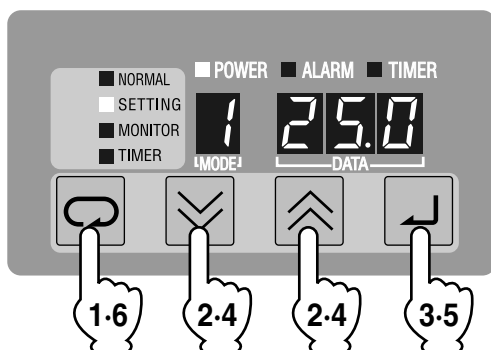

Example) Outlet oil temperature,
Fixed temperature control
(Temperature setting: 25°C)

1. Select the operation setting mode.

- Go to the operation setting mode with the key.
See "Mode changing operation" on page 17.
- The "SETTING" lamp on the operation mode indicator lights.
* The number on the operation mode display blinks.

2. Change the operation mode.

When the number on the operation mode display is blinking, change the number to "0" or "1" with the or key.

3. After changing the number, press the key to register it.

After the number is registered, the number on the data display blinks.
* The number on the operation mode display remains lit.

4. Change the temperature setting.

When the number on the data display is blinking, change the set value to a desired oil temperature with the or key.

5. After changing the set value, press the key to register it.

After the temperature setting is registered, the number on the operation mode display blinks.
* The number on the data display remains lit.

6. Return to the normal mode.

- Press the key three times, to return to the normal mode.
See "Mode changing operation" on page 17.
- The "NORMAL" lamp on the operation mode indicator lights.

Tuning Oil Temperature to Room Temperature (or Machine Temperature)

To tune the oil temperature to the room temperature (or machine temperature), the following four types of operation settings are available.

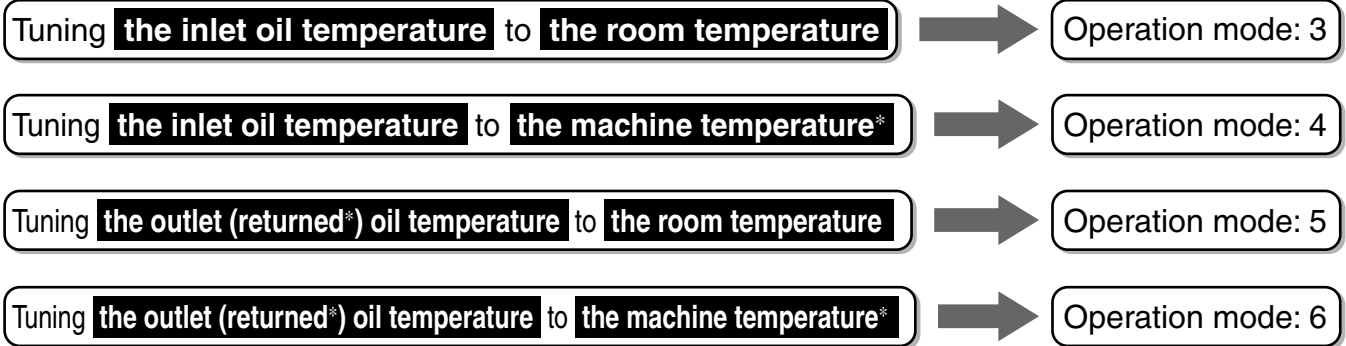

* Optional function using optional parts. See page 34-35.

With the above operation settings, the Oil Cooling Unit controls the oil temperature so as to keep the **difference** between the room or machine temperature (reference temperature) and the oil temperature (control target) at a constant value as the user specified, according to a change in the room or machine temperature. The temperature difference setting range is -9.9 to $+9.9$ (K).

Setting procedure

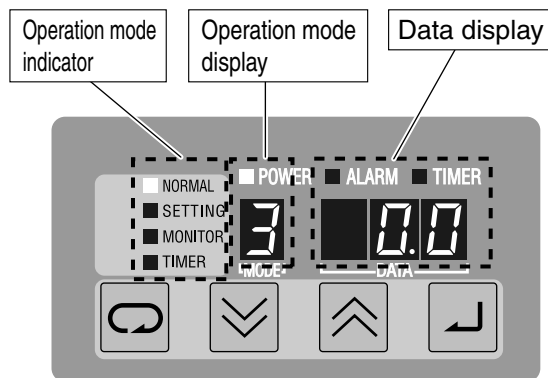

Factory setting
(With non-standard models, the settings may be different from the above.)

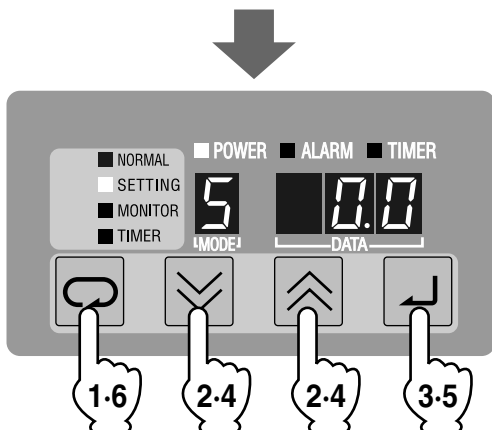

Example) Outlet oil temperature,
Room temperature tuning control
(Temperature difference setting: 0.0°C)

1. Select the operation setting mode.

- Go to the operation setting mode with the key.
See “Mode changing operation” on page 17.
- The “SETTING” lamp on the operation mode indicator lights.
* The number on the operation mode display blinks.

2. Change the operation mode.

When the number on the operation mode display is blinking, change the number to “3”, “4”, “5” or “6” with the or key.

3. After changing the number, press the key to register it.

After the number is registered, the number on the data display blinks.
* The number on the operation mode display remains lit.

4. Change the set value.

When the number on the data display is blinking, change the set value to a desired temperature difference relative to the room (machine) temperature with the or key.

5. After changing the set value, press the key to register it.

After the temperature setting is registered, the number on the operation mode display blinks.
* The number on the data display remains lit.

6. Return to the normal mode.

- Press the key three times, to return to the normal mode.
See “Mode changing operation” on page 17.
- The “NORMAL” lamp on the operation mode indicator lights.

Cooling Oil at Constant Capacity (%)

Cooling oil at **a constant capacity (%)**

Operation mode: 9

With the above operation setting, the Oil Cooling Unit executes cooling operation according to the specified capacity command (%). Oil temperature control is disabled.

The capacity setting range is 0 to 100%.

* The capacity (%) is an approximate index.

* When the capacity is set to "0", the compressor stops. (The pump and fan are running.)

* Even if the capacity command value is same, the actual cooling capacity varies depending on the room temperature and the inlet oil temperature.

Setting procedure

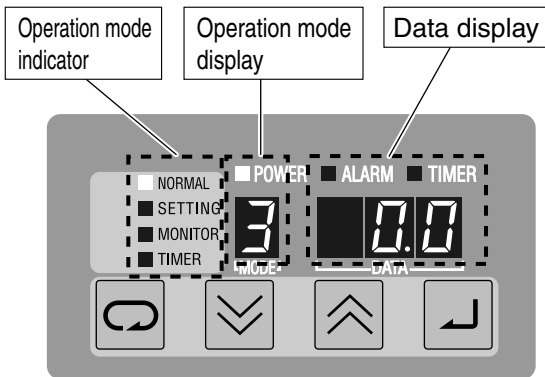

Factory setting
(With non-standard models, the settings may be different from the above.)

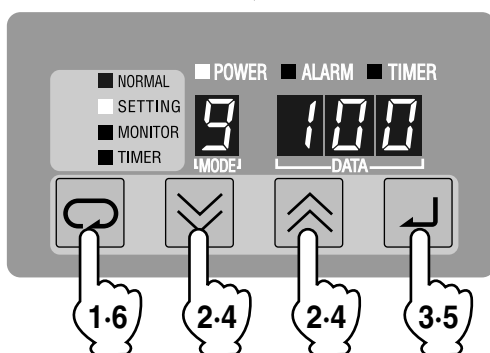

Example) Capacity direct designation
(Capacity setting: 100%)

1. Select the operation setting mode.

- Go to the operation setting mode with the key. See "Mode changing operation" on page 17.
- The "SETTING" lamp on the operation mode indicator lights.
 - * The number on the operation mode display blinks.

2. Change the operation mode.

When the number on the operation mode display is blinking, change the number to "9" with the or key.

3. After changing the number, press the key to register it.

After the number is registered, the number on the data display blinks.
* "9" on the operation mode display remains lit.

4. Change the set value.

When the number on the data display is blinking, change the set value to a desired capacity with the or key.

5. After changing the set value, press the key to register it.

After the temperature setting is registered, the number on the operation mode display blinks.
* The number on the data display remains lit.

6. Return to the normal mode.

- Press the key three times, to return to the normal mode. See "Mode changing operation" on page 17.
- The "NORMAL" lamp on the operation mode indicator lights.

Monitor Items

When the “**Monitor mode**” is selected, the following items can be checked.

No.	Description	Note
0	Machine temperature [Th5]	*1
1	Outlet oil temperature or returned oil temperature [Th2]	*1
2	Room temperature [Th3]	*1
3	Inlet oil temperature [Th4]	*1
4	Pump outlet oil temperature [Th10]	*1
5	ΔT (Th4–Th2)	*1
6	Capacity command value (%)	—
7	Compressor inverter rotation speed (rps)	—
8	Not used	*2
9	Status of expansion DIN (third digit)/DOUT (first digit)	*3

*1: Nos. 0, 1, 2, and 3 indicate a temperature detected with each thermistor.

When the relevant thermistor is not connected or has a wire break, “99.9” is displayed.

*2: “0” is displayed.

*3: With the factory setting, “J” is displayed. However, it is for indication only. Actual communication is enabled when the optional expansion communication board is mounted.

Operating procedure

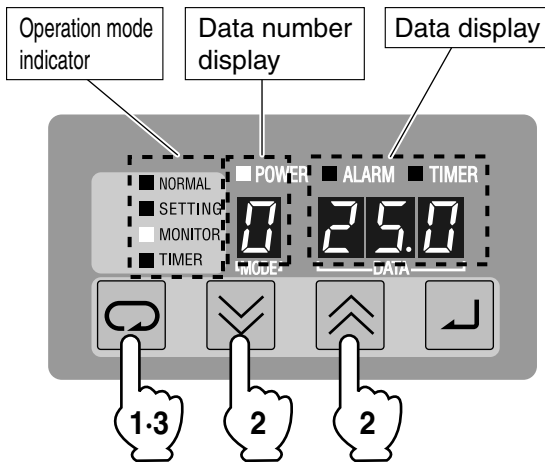

1. Select the monitor mode.

- Go to the monitor mode with the key. See “**Mode changing operation**” on page [17](#).
- The “MONITOR” lamp on the operation mode indicator lights.
 - * The value on the data number display blinks.

2. Monitor the current status.

Change the value on the data number display to a desired value with the or key.

When the data number is changed, the temperature currently detected with the thermistor and input/output values simultaneously appear on the data display.

3. Return to the normal mode.

- Press the key two times, to return to the normal mode. See “**Mode changing operation**” on page [17](#).
- The “NORMAL” lamp on the operation mode indicator lights.

Timer Operation

With the "ON" timer, the Oil Cooling Unit can be started after elapse of a desired time. This mode can be used to warm up the main machine.

The operation start time setting range is 0 to 99 hours (in one hour steps).

- * While the timer mode is selected, keep the main power supply ON.
The value indicated on the control panel will be decremented from a preset value at one-hour intervals.
- * To cancel the timer mode, set the timer at "0".
- * The timer setting is active only once. To use the timer again, you must set up the timer again.

Operating procedure

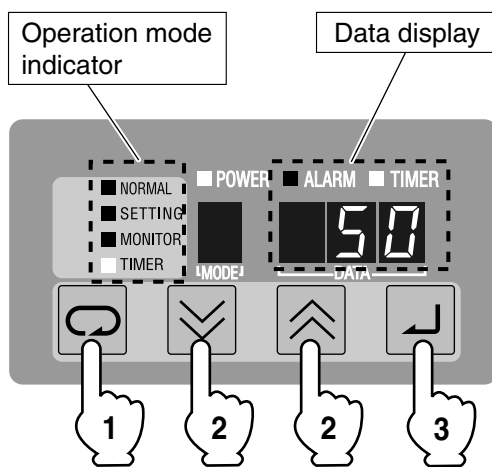

1. Select the timer mode.

- Go to the timer mode with the key.
See "Mode changing operation" on page [17](#).
- The "TIMER" lamp on the operation mode indicator lights.
* "0" blinks on the data display.

2. Specify an operation start time.

- Change the value on the data display to a desired value with the or key.
The unit of set value is "h" (hour).

3. Set up the timer.

- Press the key to register the timer setting.
- When the timer is activated, the Oil Cooling Unit is halted.
 - * The value on the data display blinks.
 - * The "TIMER" lamp (red LED) blinks.Keep the main power supply ON.

Main machine warm-up

With the built-in heater model (-H), the electric heater heats up oil to a preset temperature during main machine warm-up in winter. Combining this function with timer operation enables more effective warm-up.

Heater ON: When inlet oil temperature is at least 0.5°C lower than preset temperature

Heater OFF: When inlet oil temperature is equal to, or higher than preset temperature

Regardless of the operation mode, the Oil Cooling Unit turns ON/OFF the heater by detecting the inlet oil temperature.



(* Only when the compressor is not in operation)

Note that the heater cannot perform high-precision oil temperature control.

Additional Setting Functions

You can additionally set up the following functions by setting the parameters of the Oil Cooling Unit.

1 Additional setting functions

- Auto-tuning: Automatically sets up the parameters appropriately for the system.  page [30](#)
- Temperature range warning: Activates warning output when oil temperature exceeds preset temperature range.  page [27](#)
- Alarm/warning output logic: Outputs signal from Oil Cooling Unit to main machine.  page [33](#)
- Communication with main machine: Enables communication with main machine when optional board is mounted (see page [36](#)). Refer to HM01568.

2 Parameter list

The parameters that must be specified for individual additional setting functions are listed below:

Additional setting function				No.	Item	Minimum value	Maximum value	Initial value (Factory setting)	Unit	Necessity of power supply reset	Remarks
Auto-tuning	Warning	Alarm output logic	Communication with main machine								
				n00	Not used	0	0	0	—		
		○		n01	Alarm output logic	0	11	0	—	○	See page 33 .
		○		n02	OP contact level	0	3	0	—		
		○		n03	OP2 contact level	0	2	0	—		
○				n04	Outlet oil temperature decrease (Auto-tuning end condition)	0.0	10.0	8.0	°C		For auto-tuning See page 30 .
○				n05	P/I gain calculation coefficient (Response coefficient)	0.1	10.0	2.0	—		• The initial value varies depending on the model. (Automatically set up) by auto-tuning
○				n06	Control gain P (for low deviation)	1	999	40	—		
○				n07	Control gain I (for low deviation)	1	999	40	—		
○				n08	Control gain P (for high deviation)	1	999	40	—		
○				n09	Control gain I (for high deviation)	1	999	40	—		
	○			n10	Warning setting 1	0	465	0	—		See page 27 .
	○			n11	Warning setting data 1	0.0	60.9	0.0	—		
	○			n12	Warning setting 2	0	465	0	—		
	○			n13	Warning setting data 2	0.0	60.9	0.0	—		
	○			n14	Warning setting 3	0	465	0	—		
	○			n15	Warning setting data 3	0.0	60.9	0.0	—		
	○			n16	Warning setting 4	0	465	0	—		
	○			n17	Warning setting data 4	0.0	60.9	0.0	—		
	○			n18	Warning setting 5	0	465	0	—		
	○			n19	Warning setting data 5	0.0	60.9	0.0	—		
			○	n20	Use of parallel communication	0	1	0	—	○	The optional board is required. See page 36 .
				n21 to n38	/	—	—	—	—		Never attempt to change these settings. Otherwise, the unit may malfunction.

3 Parameter setting procedure

You can set the parameter that enables the additional setting functions of the Oil Cooling Unit.
For description of the additional setting functions and parameter list, refer to page 25.

Setting procedure

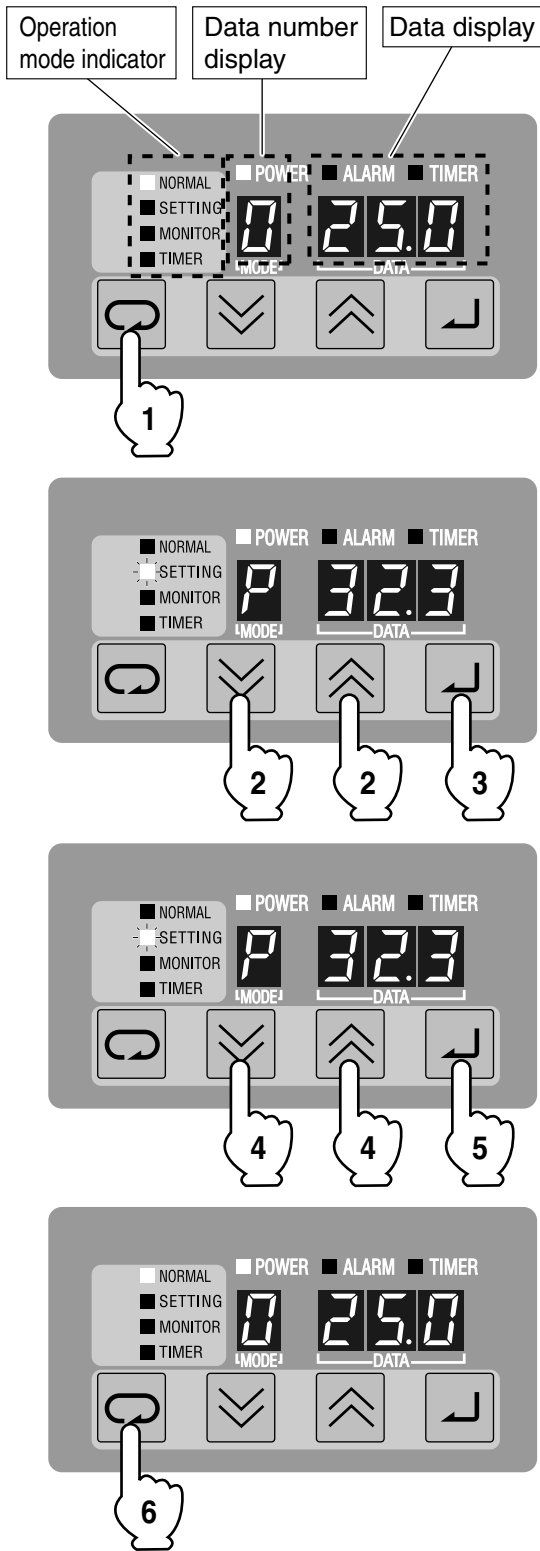



1. Select the parameter setting mode.

- Go to the parameter setting mode by pressing the  key for two seconds.

See “Mode changing operation” on page 17.

- The “SETTING” lamp on the operation mode indicator lights.
 - * “P” blinks on the data number display.

2. Select a parameter number.



Change the parameter number to a desired number with the  or  key.

- After the selected parameter number is displayed for approx. 0.5 seconds on the data display, the set value appears.

3. Register the parameter number.

- Press the  key to register the parameter number.
- After the number is registered, the value on the data display blinks.
 - * “P” on the data number display remains lit.

4. Change the set value.

When the value on the data display is blinking, change the set value with the  or  key.

5. After changing the set value, press the key to register it.

After the set value is registered, the value on the data display remains lit.

- * “P” blinks on the data number display.

6. Return to the normal mode.

- Press the  key, to return to the normal mode.
 - See “Mode changing operation” on page 17.
- The “NORMAL” lamp on the operation mode indicator lights.

Setting Additional Function—“Temperature range warning”

■ Outline of the function

- As an additional function of the Oil Cooling Unit, you can set up the “**Temperature range warning**” function. This function allows you to specify a desired temperature range within the Oil Cooling Unit operating range. When the control temperature exceeds the preset range, the unit informs you of the “Temperature range warning” condition.
- The “Temperature range warning” function provides the following settings:
 - External output (30X relay output: ON): Turns ON/OFF the contact (66, 67) of the signal terminal block.
(See the output logic on page [33](#).)
 - Compressor forced stop—Warning: Stops the compressor. (Indication: 1E to 5E)
Warning status will be automatically reset when preset warning reset temperature is reached.
 - Alarm stop—“FH” alarm: Stops the compressor. (Indication: FH)
(See “Alarm output logic” on page [10](#).)
The warning reset setting is inactive. (When the power supply is turned ON again, the compressor restarts operation.)

* The above 1), 2) and 3) can be combined.

■ Parameter setting

To enable this function, set the corresponding parameters. You can specify up to five warning conditions with the following five groups of parameters.

	Types of temperature range warning*	Parameter	
		Group A	Group B
(1)	Low oil temperature (Fixed temperature)	n10	n11
(2)	High oil temperature (Fixed temperature)	n12	n13
(3)	Low oil temperature (Temperature difference)	n14	n15
(4)	High oil temperature (Temperature difference)	n16	n17
(5)	Reserve	n18	n19

Group A: “Temperature range warning condition setting”
“Temperature range warning operation setting”

Group B: “Temperature range warning temperature setting”
“Temperature range warning reset temperature setting”

* For temperature range warning, the above (1) to (5) types are available. Actually, however, any combinations of these types are enabled. The above (1) to (5) types can be simultaneously used.

Application of temperature range warning

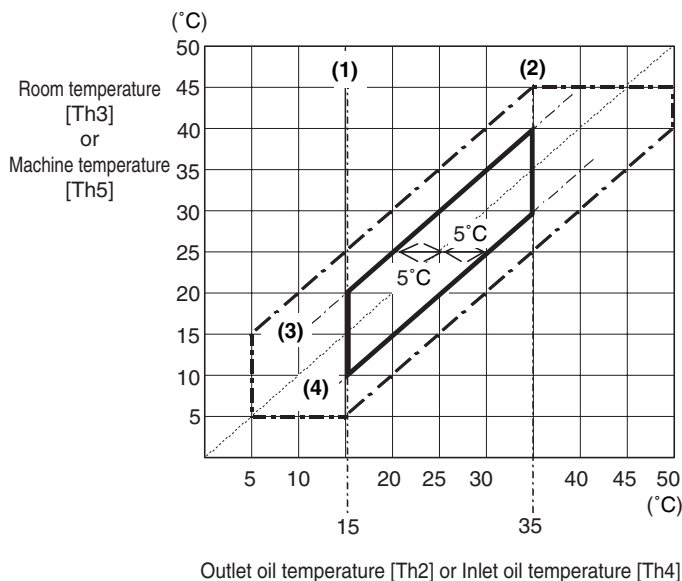

- When the outlet oil temperature [Th2] (or inlet oil temperature [Th4]) is 15°C or lower, the compressor stops. (Warning)
- When the outlet oil temperature [Th2] (or inlet oil temperature [Th4]) is 35°C or higher, the compressor stops (FH alarm), and the 30X relay output turns ON.
- When the outlet oil temperature [Th2] (or inlet oil temperature [Th4]) is at least 5°C lower than the room temperature [Th3] (or machine temperature [Th5]), the 30X relay output turns ON.
- When the outlet oil temperature [Th2] (or inlet oil temperature [Th4]) is at least 5°C higher than the room temperature [Th3] (or machine temperature [Th5]), the 30X relay output turns ON.

: Oil Cooling Unit operating range
 : Temperature range warning setting

Description on parameter settings (Group A)

*Enter Group B (page 29) before Group A, so that the temperature range warning is not activated during setup.

In this section, set the following parameters by using three digits (first, second and third digits) of each parameter on the control panel data display.

- “Temperature range warning condition setting” (Use the second and third digits.)
- “Temperature range warning operation setting” (Use the first digit.)

		Temperature range warning condition setting		Temperature range warning operation setting			
		Third digit	Second digit	First digit			
(1)	n10	Outlet oil temperature [Th2]	2	≤ Fixed value	6	External output (“Rely 30” output: ON)	1
		Inlet oil temperature [Th4]	4			Warning	2
						Warning + External output (“Rely 30” output: ON)	3
(2)	n12	Outlet oil temperature [Th2]	2	≥ Fixed value	5	External output (“Rely 30” output: ON)	1
		Inlet oil temperature [Th4]	4			FH alarm	4
						FH alarm + External output (“Rely 30” output: ON)	5
(3)	n14	Room temperature [Th3]	3	– Outlet oil temperature [Th2]	2	External output (“Rely 30” output: ON)	1
		Machine temperature [Th5]	1	– Inlet oil temperature [Th4]	4	Warning	2
						Warning + External output (“Rely 30” output: ON)	3
(4)	n16	Outlet oil temperature [Th2]	2	– Room temperature [Th3]	3	External output (“Rely 30” output: ON)	1
		Inlet oil temperature [Th4]	4	– Machine temperature [Th5]	1	FH alarm	4
						FH alarm + External output (“Rely 30” output: ON)	5

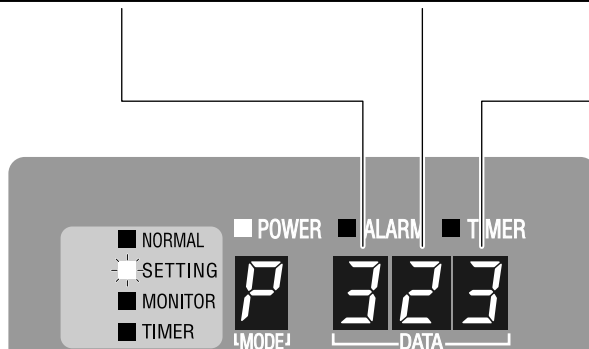

Example of parameter settings (for temperature range warning: See page 27.)

(1)	When the outlet oil temperature [Th2] (or inlet oil temperature [Th4]) is 15°C or lower, the compressor stops. (Warning)	n10	262 (462)
(2)	When the outlet oil temperature [Th2] (or inlet oil temperature [Th4]) is 35°C or higher, the compressor stops (FH alarm), and the 30X relay output turns ON.	n12	255 (455)
(3)	When the outlet oil temperature [Th2] (or inlet oil temperature [Th4]) is at least 5°C lower than the room temperature [Th3] (or machine temperature [Th5]), the 30X relay output turns ON.	n14	321 (141)
(4)	When the outlet oil temperature [Th2] (or inlet oil temperature [Th4]) is at least 5°C higher than the room temperature [Th3] (or machine temperature [Th5]), the 30X relay output turns ON.	n16	231 (411)

Description on parameter settings (Group B)

In this section, set the following parameters by using three digits (first and second digits, and first decimal place) of each parameter on the control panel data display.

- “Temperature range warning temperature setting” (Use the first and second digits.)
- “Temperature range warning reset temperature setting” (Use the first decimal place. Active only when “Warning” has been set.)

		Temperature range warning temperature		Temperature range warning reset temperature (Temperature difference for automatic reset)* ¹
		Second digit	First digit	First decimal place
(1)	n11	0 to 60 (°C)		1 to 9 (°C)
(2)	n13			
(3)	n15			
(4)	n17			

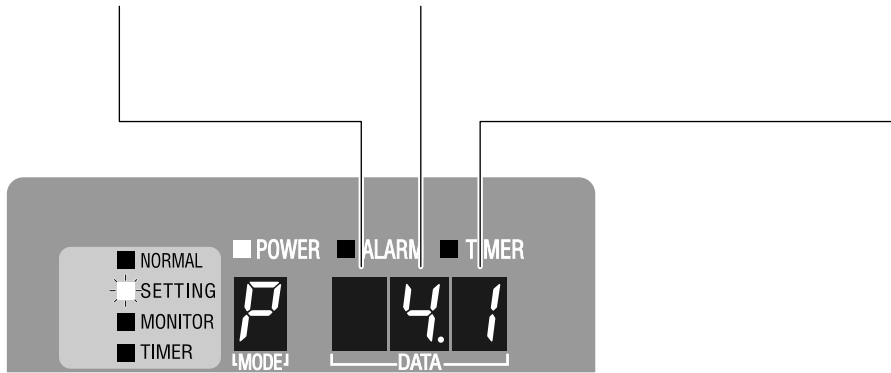

*1: When the first digit of the “temperature range warning operation setting” parameter of **Group A** is “4” or “5”, this parameter is inactive because the warning status will not be automatically reset. (Enter any number from 0 to 9.)

Example of parameter settings (for temperature range warning: See page 27.)

(1)	When the outlet oil temperature [Th2] (or inlet oil temperature [Th4]) is 15°C or lower, the compressor stops. (Warning) [When outlet oil temperature [Th2] becomes 17°C, the warning status will be automatically reset.]	n11	15.2* ²
(2)	When the outlet oil temperature [Th2] (or inlet oil temperature [Th4]) is 35°C or higher, the compressor stops (FH alarm), and the 30X relay output turns ON.	n13	35.0
(3)	When the outlet oil temperature [Th2] (or inlet oil temperature [Th4]) is at least 5°C lower than the room temperature [Th3] (or machine temperature [Th5]), the 30X relay output turns ON. [When the difference between room temperature [Th3] and outlet oil temperature [Th2] becomes 4°C or less, the warning status will be automatically reset.]	n15	5.1* ³
(4)	When the outlet oil temperature [Th2] (or inlet oil temperature [Th4]) is at least 5°C higher than the room temperature [Th3] (or machine temperature [Th5]), the 30X relay output turns ON. [When the difference between room temperature [Th3] and outlet oil temperature [Th2] becomes 3°C or less, the warning status will be automatically reset.]	n17	5.2* ⁴

*2: 17 (Temperature range warning reset temperature) – 15 (Temperature range warning temperature) = 2

*3: 5 (Temperature range warning temperature) – 4 (Temperature range warning reset temperature) = 1

*4: 5 (Temperature range warning temperature) – 3 (Temperature range warning reset temperature) = 2

For Temperature Control Improvement—“Auto-tuning mode”

* To use the Oil Cooling Unit in normal conditions, this function is not required.

■ Outline of the function

Depending on the system of the main machine, problems of “unstable temperature control” or “slow response in temperature control” may be raised. In such cases, it is possible that the temperature control gain* P or I setting is not suitable for the system.

* Temperature control gain: Coefficient to determine a control value according to deviation (temperature difference)

P: Proportional gain

I: Integral gain

In such cases, you can improve the temperature control performance by using the “Auto-tuning mode” that provides more suitable gain settings.

Auto-tuning (Conceptual drawing)

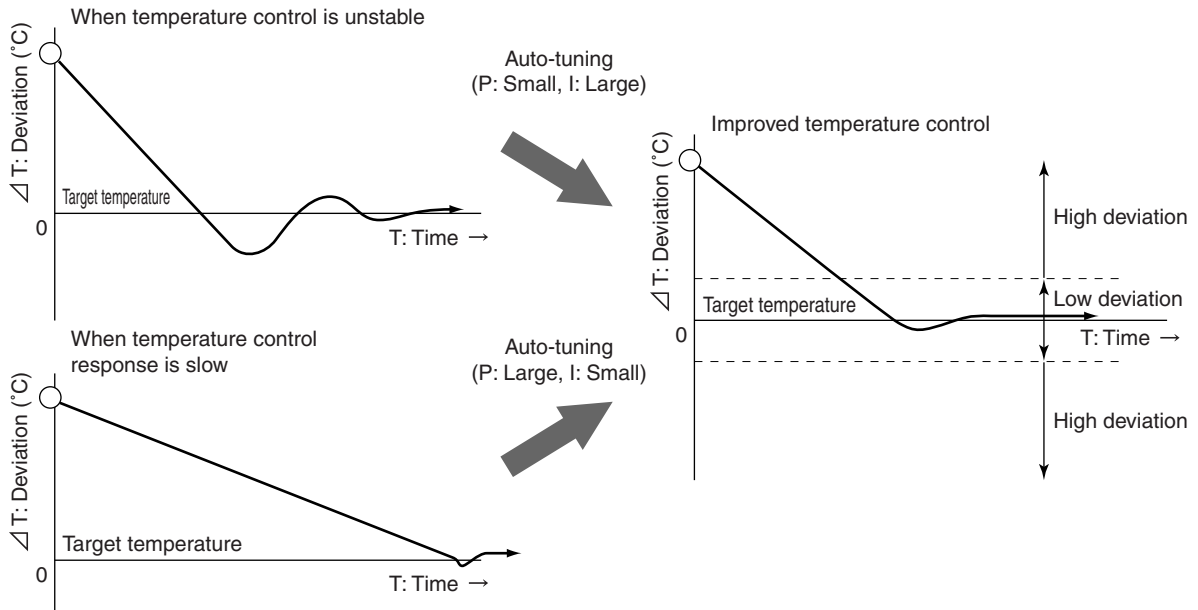

Parameter No.	Item
n05	P/I gain calculation coefficient (Response coefficient)
n06	Temperature control gain P (for low deviation)
n07	Temperature control gain I (for low deviation)
n08	Temperature control gain P (for high deviation)
n09	Temperature control gain I (for high deviation)

The auto-tuning mode automatically writes calculated values of temperature control gain (P and I) into specified parameters.

Initial value: 2.0
 Calculated temperature control gain P
 Calculated temperature control gain I

■ Factory settings of the standard model
 P: 40
 I: 40

■ Outline of operation

The auto-tuning mode executes the following steps.
 Check the Oil Cooling Unit status in each step.

Step	Operation	Unit status	Remarks
Before start	—	Operation status (Operation mode: Other than 9)	Select a desired operation mode. *[Note] 1., 3.
Step 0	Checking tuning conditions	Operation status (Operation mode: Other than 9: Same as before start)	
Step 1	Operation for stabilizing initial status	Operation status (Automatic operation for 2 minutes at 1% capacity)	
Step 2	Operation for collecting control target data	Operation status (Automatic operation for 10 minutes at 100% capacity)	*[Note] 4.
Step 3	Calculation of temperature control gain P and I from collected data, and writing gain into each parameter	Stop	*[Note] 5.
After completion	—	Stop	*[Note] 6.

Operation flow

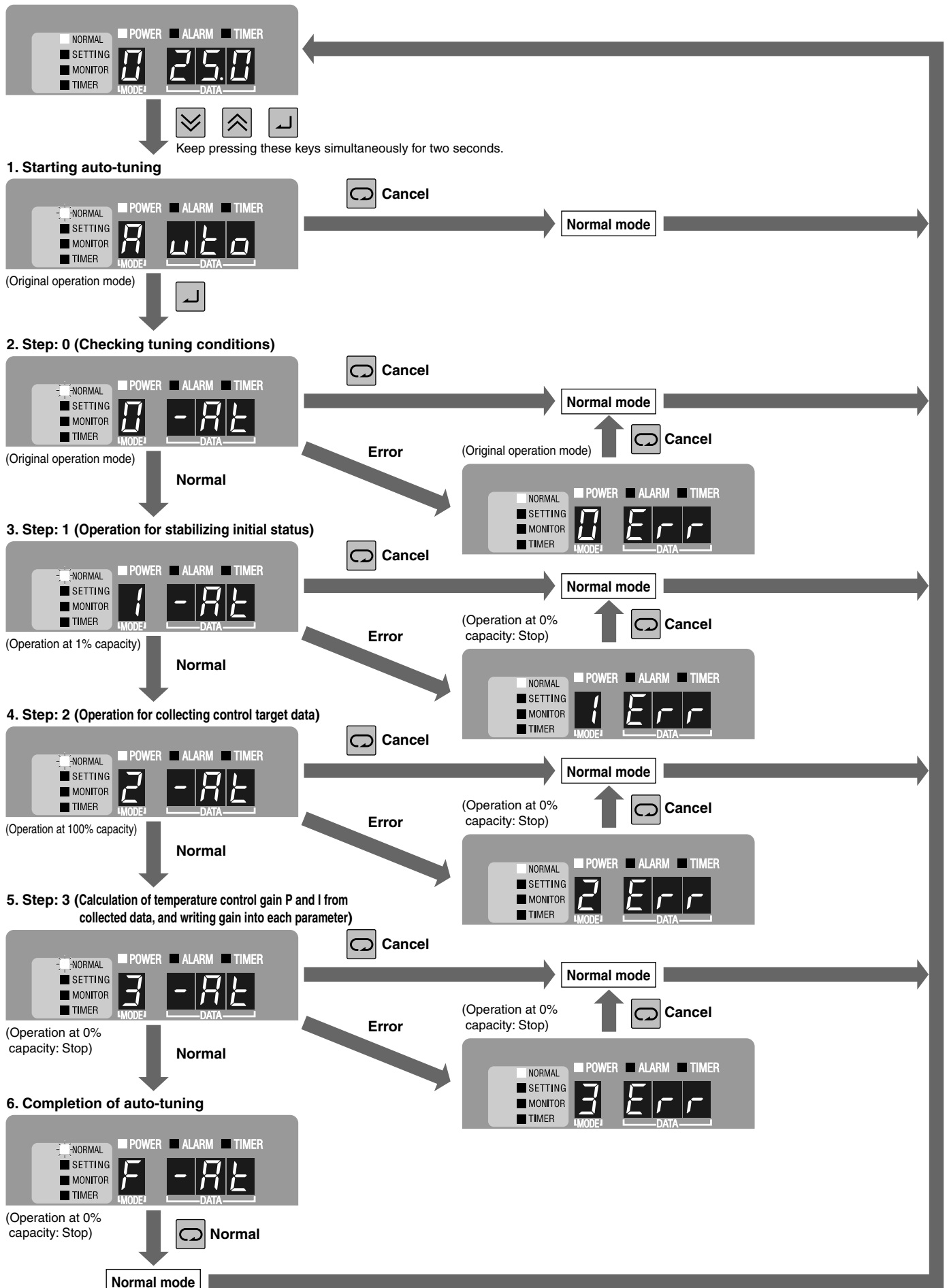

Useful Functions Handling

[Note]

1. When starting auto-tuning, make sure that **the oil temperature is nearly equal to the room temperature (in stable condition)**. Leave the main machine under no load (stopped).

2. If **the remote signal turns OFF or an alarm is activated** during execution of auto-tuning, an error occurs (auto-tuning cannot be executed), and the corresponding error message appears.

To cancel the error, press the  key. (The unit returns to the normal mode.)

Check the remote signal, or examine the cause of the alarm. After taking a corrective action, execute auto-tuning again.

3. Before starting auto-tuning, select an operation mode to determine the control target thermistor. (Select any operation mode other than "9".)

Operation mode 0, 3 or 4 ⇒ Inlet oil temperature thermistor

Operation mode 1, 5 or 6 ⇒ Outlet oil temperature thermistor

Then, set Parameter [n04] by referring to [Note] 4. below.

4. In Step 2, the machine may be over-cooled. To suppress machine over-cooling, specify an auto-tuning end condition in Parameter [n04].

Parameter [n04] Outlet oil temperature decrease (Auto-tuning end condition)

Setting range: 0.0 to 10.0°C, Initial value: 8.0°C

When the outlet oil temperature decreases by the temperature specified in this parameter, auto-tuning (data collection) ends.

If the specified temperature range is too small, temperature control gain may not be correctly calculated. You should set this parameter to the maximum value in the range where it does not cause damage to the machine.

5. To calculate more suitable temperature control gain based on the data collected in Step 3, you must specify a response coefficient in Parameter [n05]. (Through response coefficient adjustment, you can select whether to place importance on stability or response speed.)

Parameter [n05] P and I gain calculation coefficient (Response coefficient)

Setting range: 0.1 to 10.0, Initial value: 2.0

Setting a smaller value improves stability. Setting a larger value improves response speed.

If the set value is extremely large or small, the unit may not normally perform temperature control. First, you should execute auto-tuning with the initial value of 2.0.

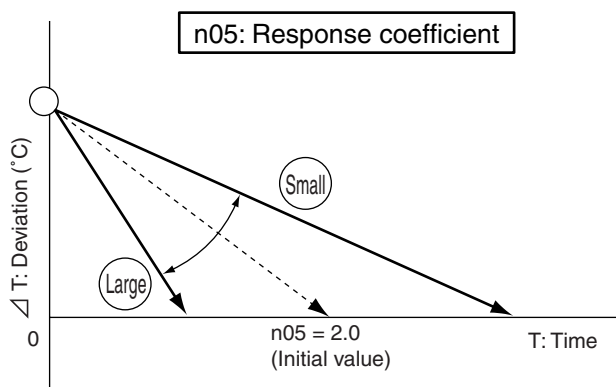

6. Depending on the condition of the control target (machine), the unit may not calculate suitable temperature control gain in a single auto-tuning operation. You should **execute auto-tuning two or three times to average the calculated values, or use the value that most frequently appears (except for an extreme value)**.

To calculate a more suitable temperature control gain, you may change Parameter [n05] (see [Note] 5. above).

7. In the following cases, temperature control is not stabilized because the compressor turns ON/OFF without being subjected to inverter control.

(1) Operation under small load (Cooling capacity: 5% or less)

(2) Rapid load change (Transition period)

Alarm/Warning Output Logic

The Oil Cooling Unit can output an operation status signal to the main machine through wiring to the signal terminal block and parameter setup.

1. Connect the required signal cable to the signal terminal block.
(For the connecting method, refer to "Connection of external output contact" on page [10](#).)
2. Set Parameter [n01].
n01: Alarm/warning output logic (First digit).

Setting		0			1 (2 to 9: Same operation as with 1)		
	Contact	Normal	Power failure	Alarm	Normal	Power failure	Alarm
Alarm output	60–61	ON	OFF	OFF	OFF	OFF	ON
	60–63	OFF	ON	ON	ON	ON	OFF
Temperature range warning output	66–67	ON	OFF	OFF	OFF	OFF	ON

First digit: Specifies alarm output logic (60, 61, 63) and warning output logic (66, 67) of the signal terminal block.

Second digit: Specifies DOUT signal output logic. (Optional communication expansion board is required.)

For details, refer to "Communication Expansion Board Instruction Manual" (HM01568).

Alarm Settings for Optional Protection Devices (Installed by User)

The Oil Cooling Unit can activate an alarm by receiving an output signal from optional protection devices (e.g. flow switch, level switch).

When using OP terminals [12] and [13]:

1. Connect the signal cable of the optional protection device to terminals [12] and [13] on the Oil Cooling Unit signal terminal block.
(See "Outline of electrical equipment box" on page [9](#).)
2. Set Parameter [n02].
 - "0": OP terminal is not used. (Factory setting)
 - "1": When OP contact turns OFF, Alarm Level 1 is activated.
 - "2": When OP contact turns OFF, Alarm Level 2 is activated.
 - "3": When OP contact is not ON after 30 seconds from pump operation start, Alarm Level 1 is activated.
(When flow switch is used)

[CAUTION] The protection function cannot be activated simply by connecting the protection device to the OP terminals.
Be sure to set this parameter.

When using OP 2 terminal [CN2]:

1. Connect the signal cable of the optional protection device to [CN2] on the Oil Cooling Unit control board.
(See "Outline of electrical equipment box" on page [9](#).)
2. Set Parameter [n03].
 - "0": OP2 terminal is not used. (Factory setting)
 - "1": When OP2 contact turns OFF, Alarm Level 1 is activated.
 - "2": When OP2 contact turns OFF, Alarm Level 2 is activated.

[CAUTION] The protection function cannot be activated simply by connecting the protection device to the OP terminals.
Be sure to set this parameter.

Optional Parts

Machine temperature tuning control

See page 19.

When the following optional parts are mounted to the main machine, the Oil Cooling Unit can perform control by detecting the machine temperature.

Optional Parts

Name	Type	Lead wire length L (m)	Dimensions	Application (Installed by user)	Compatible model
Machine temperature tuning thermistor	AKZ8-OP-K5	(5 m)		For machine temperature tuning control (embedded in machine body)	AKZ8 series AKZJ8 series
	AKZ8-OP-K10	(10 m)			
	AKZ8-OP-A5	(5 m)		For machine temperature tuning control (attached to machine body surface)	
	AKZ8-OP-A10	(10 m)			

Characteristics of thermistor: Resistance R25 (resistance at 25°C) = 20 kΩ, Tolerance: ±2%

Mounting procedure

Oil Cooling Unit

Connect the round terminal (1.25-3) of the above part to terminals [30] and [31] of the X2M terminal block in the electrical equipment box. (No polarity)
(See "Outline of electrical equipment box" on page 9.)

Main machine

For AKZ8-OP-K

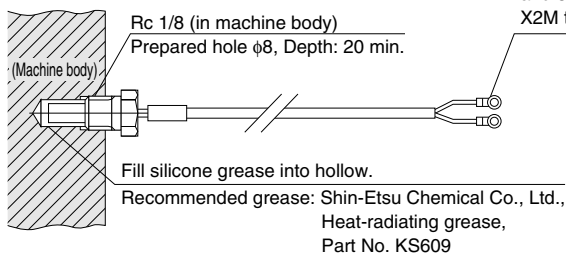

Connection to terminals 30 and 31 of Oil Cooling Unit X2M terminal block

For AKZ8-OP-A

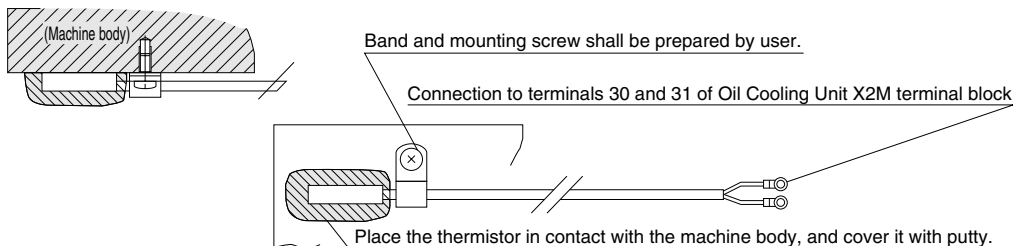

CAUTION



- If the sensor is directly exposed to wind, detected temperature may fluctuate. Be sure to take heat-insulation measures by applying putty.
- When using a sensor of screw-mounting type, screw the sensor all the way into the body of the detection target.

Optional Parts

Returned oil temperature control

See page 19.

When the following optional parts are mounted to the oil piping (return oil piping) of the main machine, the Oil Cooling Unit can perform control by detecting the returned oil temperature.

Optional parts

Name	Type	Lead wire length L (m)	Dimensions	Application (Installed by user)	Compatible model
Oil temperature control thermistor	AKZ8-OP-Y5	(5 m)		For returned oil temperature control (Mounted to main machine oil piping)	AKZ8 series
	AKZ8-OP-Y10	(10 m)			

Characteristics of thermistor: Resistance R25 (resistance at 25°C) = 20 kΩ, Tolerance: ±2%

Mounting procedure

Oil Cooling Unit

Substitute the blue connector (XHP-3) of the above part for the blue connector [CN11] of the outlet oil temperature thermistor in the electrical equipment box. (See "Outline of electrical equipment box" on page 9.)

Main machine

For AKZ8-OP-Y

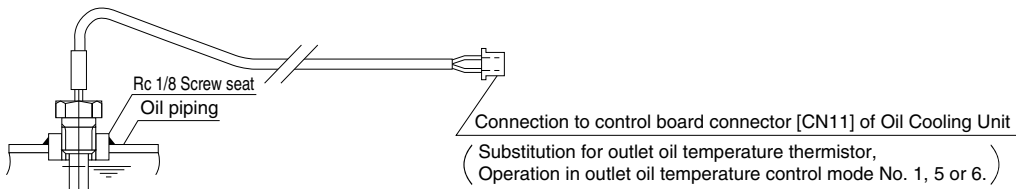

Optional Parts

Communication with main machine

When this optional board is mounted to the Oil Cooling Unit to connect this unit to the main machine:

1. You can change the operation mode and operation setting from the main machine.
2. You can read the Oil Cooling Unit alarm code and temperature data (machine temperature, room temperature, inlet oil temperature, outlet oil temperature, temperature difference between inlet and outlet, and inverter frequency data) from the main machine.

* To execute parallel communication, you must set the corresponding parameter. (See page 25.) The Oil Cooling Unit cannot communicate with the main machine simply by mounting this optional board. For serial communication, parameter setting is not required.

Optional parts

Communication method	Type	Mounting position	Compatible model	Specification No.
Serial communication only	AKZ8-OP-CS	Upper surface of Oil Cooling Unit control board	AKZ148, AKZ328, AKZ438, AKZJ188, AKZJ358, AKZJ458	SS08303
		Back of Oil Cooling Unit electrical equipment box front sheet metal	AKZ568, AKZ908, AKZJ568, AKZJ908	
Serial or parallel communication	AKZ8-OP-CSP	Back of Oil Cooling Unit electrical equipment box front sheet metal	AKZ568, AKZ908, AKZJ568, AKZJ908	SS08370

Mounting procedure

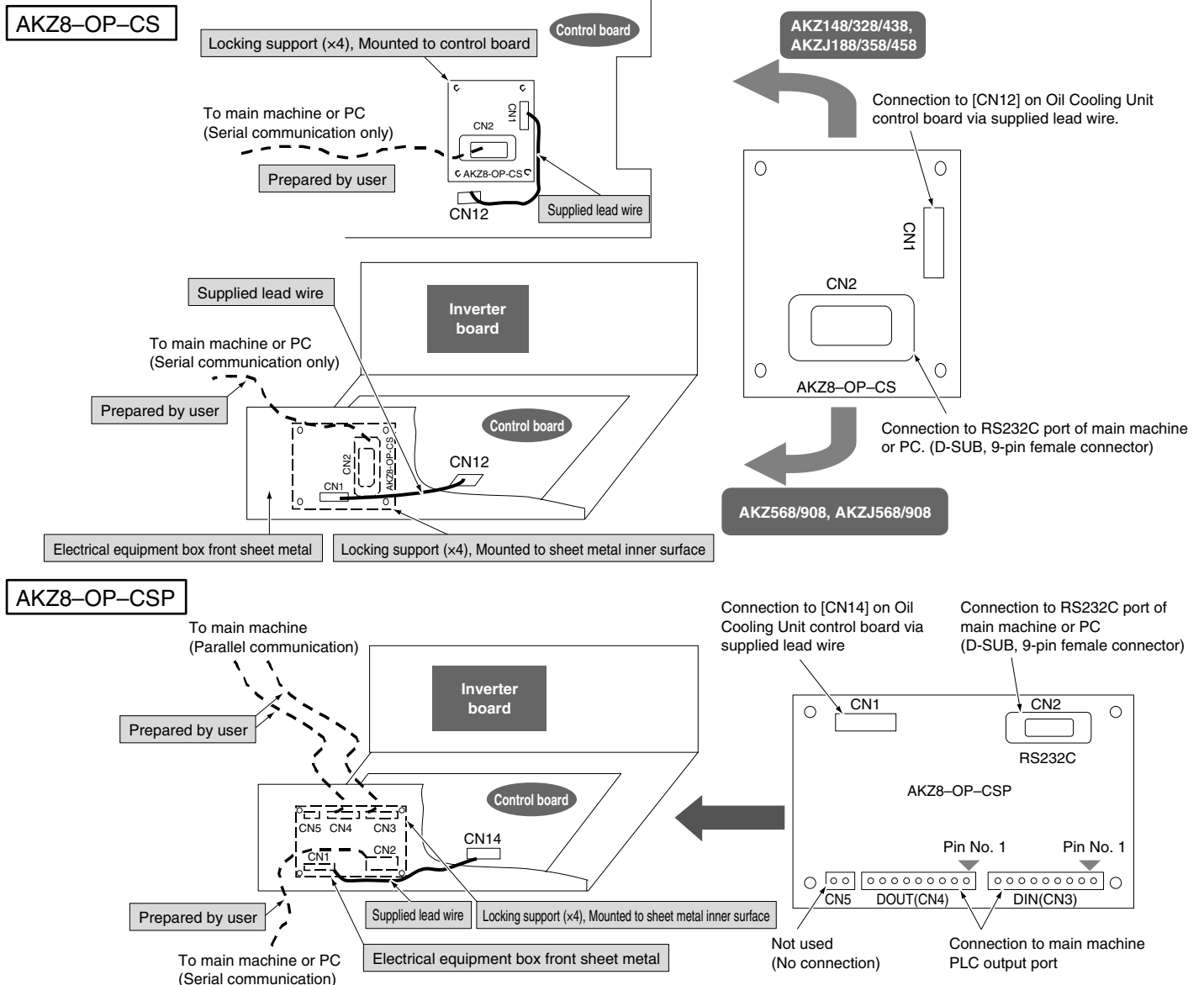

Maintenance/Inspection

Daily maintenance/inspection

- Oil pollution causes a fault or shortened service life of the pump. Use thorough caution about oil pollution to maintain the pollution degree at NAS10 or lower level.
- Keep a normal oil level in the oil tank. Make sure that the oil does not contain air bubbles.
- Clean inside of the oil tank periodically.
- Make sure that the main machine oil piping is not blocked (fully closed).
- Make sure that the oil piping has no oil leak.
- Make sure that the power supply voltage is within the following range:
50 Hz.....200 V \pm 10%
60 Hz.....200/220 V \pm 10%
- Make sure that the compressor, fan and oil pump do not abnormally sound during operation.
- Make sure that the Oil Cooling Unit does not abnormally shake during operation.

Periodic maintenance/inspection

Suction strainer

- Clean the suction strainer every six months to prevent the pump flow rate from being reduced by dust clogging, and to prevent abnormal sound caused by cavitation.

Air filter (See page 15.)

- Be sure to wash the air filter with water at 40°C or lower temperature every two weeks.
If the air filter is clogged with dust, the wind volume reduces, resulting in capacity deterioration. Also, the compressor's protection device is activated, hindering smooth operation. Furthermore, it causes power consumption increase.
- Operating the unit without the air filter causes a fault.
- To remove the air filter, hold the bottom of the filter with both hands, and push it up while warping it forward.

If the air filter is clogged, the cooling capacity deteriorates, resulting in excess power consumption. Clean the air filter periodically to save power consumption.

Condenser (See page 15.)

- If the condenser becomes extremely dirty, clean it with a brush, air blower, etc.
(When cleaning the condenser fins, wear gloves. Otherwise, you may be injured by the sharp edges.)

Exterior

- Wipe the exterior surface with a dry cloth.
Never splash water over it.
- To clean the exterior, do not use a brush, polish powder, acid, solvent (benzine etc.) or hot water. Using such substances causes the paint to peel off.

To leave the unit unused for a long period

- Mount a cover to the Oil Cooling Unit to prevent dust or water from entering inside of the unit.
- Be sure to turn OFF the main power supply.
- Be careful to keep oily dust off the condenser surface of the Oil Cooling Unit.

Troubleshooting

1 When the Oil Cooling Unit does not work well, first check the following points.

2 If the problem persists, contact DAIKIN Contact Center with information on the following 1), 2) and 3) items. (For phone/fax number and address of DAIKIN Contact Center, see the back cover.)

- 1) Machine name (Full Model No.) } See page 4.
 2) Manufacture No. (MFG. No.) }
 3) Condition of the Oil Cooling Unit (as closely as possible)

When the unit operation seems abnormal although no alarm is activated

Item	Condition	Cause	Corrective action
1	The unit does not run at all. (The POWER lamp on the control panel is unlit.)	1) The main power supply is OFF, or the power cable (L1, L2) is disconnected.	Check if the power cable is connected to the power supply terminal.
2	The pump does not run.	1) The remote control input ([10]–[11]) is OFF.	Check the connection of the remote control input.
		2) The unit has been set to the operation lock mode. (With the factory setting, the operation lock mode is selected.)	Cancel the LOCK mode on the control panel. (See page 17.)
3	Oil does not flow, although the pump is running. Because the oil circulation quantity is insufficient, the pump sound level is large.	1) The pump suction pipe connection is loose.	Check the packing of the pipe, and re-tighten it securely.
		2) The suction strainer is clogged.	Clean the suction strainer. If the oil in the oil tank is dirty, replace the oil. (See page 37.)
		3) The oil level in the oil tank has decreased.	Refill oil into the oil tank.
		4) Because of a large pressure loss in the oil discharge pipe, the pump relief valve is activated.	Increase the oil pipe diameter, and shorten the pipe length.
		5) Because of a large pressure loss in the oil suction pipe, cavitation has occurred with the pump.	
4	The compressor does not run, although the pump is running.	1) The compressor is stopped under temperature control.	---
		2) The compressor restart prevention timer has been activated (for 30 seconds).	Check if the compressor starts after elapse of the timer preset time.
		3) The low oil temperature protection device has been activated. (Inlet oil temperature is 2°C or lower.)	Check if the compressor normally operates at 5°C or higher oil temperature.
		4) The low ambient temperature protection device has been activated. (Room temperature is –2°C or lower.)	Check if the compressor normally operates at 0°C or higher room temperature.
		5) The capacity setting is 0% (Mode 9).	Change the operation mode to an appropriate setting.
5	Although both pump and compressor are running, oil cannot be cooled.	1) There is an obstacle near the air intake/exhaust port.	Remove the obstacle.
		2) The air filter is clogged.	Clean the air filter.
		3) The unit is running under capacity suppressing control, because the room temperature is high.	Check the capacity in the operating temperature range with the catalog, and select a model with appropriate capacity.
		4) Heat load is large.	
		5) The temperature setting is high.	Change the temperature setting to an appropriate temperature.
		6) If the exhaust air temperature is almost equal to the room temperature although the compressor is in operation, the refrigerant gas is running short.	Re-fill refrigerant.
6	Operation setting cannot be performed.	1) If “---” appears on the data display, the temperature sensor corresponding to the selected operation mode is not connected.	Connect the corresponding temperature sensor.
		2) If “---” instantaneously appears when the [ENT] key (at the right end of the control panel) is pressed, the erroneous operation prevention switch is set to ON.	Turn OFF the erroneous operation prevention switch (SW1) on the control board.
7	Alarm output operation ([64] or [65]) is different from that of conventional signal output.	1) The alarm output signal connection has been partially changed.	The [60] to [63] outputs are compatible with conventional models (AKS5 and AKZ6 series). With the AKZ8 series, however, signal operations and connections of the [64] and [65] outputs have been changed.

When an alarm is activated (To cancel the alarm, turn OFF the power supply, and then turn it ON again.)

Alarm list

Alarm code	Alarm* level	Description	Cause	Corrective action
AA	2	Heater overheat (S4B1:CN4) (For built-in heater model only)	1) AKZ type: No oil flow	Check if the oil circuit is properly connected and the pump normally operates.
			2) AKZJ type: Insufficient oil level in tank	Refill oil.
A6	2	DC fan motor lock error	1) Fault of the DC fan motor	Replace the DC fan motor.
			2) Fan motor-control board communication error	Check the connector insertion and wire break. Replace the control board.
E1	1	System error	1) Internal parameter setting is invalid.	Replace the control board.
E3	2	High pressure error (High-pressure pressure switch (S3PH:CN6), Activated at 4.1 MPa)	1) The oil temperature or room temperature is higher than the specified range.	Use the unit within the specified operating range.
			2) There is an obstacle near the air intake/exhaust port.	Do not place any object that blocks ventilation at 500 mm or shorter distance from the air intake/exhaust port.
			3) The air filter is clogged, or the condenser is dirty.	Clean the air filter. (See "Maintenance/Inspection" on page 37.)
			4) Any factor other than the above	Contact DAIKIN Contact Center.
E5	2	Compressor high temperature error (Discharge pipe thermostat Th6, Activated at approx. 120°C) (Compressor head thermostat (S2B:CN5), Activated at 115°C)	1) The oil temperature or room temperature is higher than the specified range.	Use the unit within the specified operating range.
			2) There is an obstacle near the air intake/exhaust port.	Do not place any object that blocks ventilation at 500 mm or shorter distance from the air intake/exhaust port.
			3) The air filter is clogged, or the condenser is dirty.	Clean the air filter. (See "Maintenance/Inspection" on page 37.)
E6	2	Compressor (M2C) lock	1) Fault of the compressor (Replace the compressor.)	Replace the compressor.
EH	1	Pump over-current relay (S1B:CN3) is activated. AKZ148, 328, 438: 2.5A AKZ568, 908: 3.6A	1) The pump is overloaded with high-viscosity oil.	Use an operating fluid that provides 4 to 200 mm ² /s viscosity in the specified oil temperature range.
			2) Because the power supply voltage falls below the operating range, the pump current has increased.	Check if the power supply voltage is not lower than the specified operating range. Check for an instantaneous power supply voltage drop at startup of peripheral equipment.
			3) The pump motor wiring has a break. (Open-phase)	Replace the pump motor.
			4) A foreign object is caught in the pump, or the pump motor has a fault.	Replace the pump motor.
EJ	1 or 2	Optional protection device is activated. (OP.)	1) The optionally-connected protection device (or factory-connected device, if it is incorporated in the unit) has been activated.	Check the condition detected with the relevant protection device.
H1	2	Air temperature thermistor error (Th5: Machine temperature tuning thermistor) (Th3: Room temperature thermistor)	1) The air temperature thermistor required for control is disconnected or short-circuited.	Identify the thermistor that indicates the error in the monitor mode on the operation panel ("99.9" is displayed), and check the thermistor wiring.
FE	1	Pump outlet oil temperature error (Th10)	1) The pump outlet oil temperature is higher than 65°C.	Check if the oil piping system is not blocked (fully closed).
FH	2	Inlet oil temperature is higher than 60°C.	1) The heating value of the main machine has exceeded the cooling capacity of the Oil Cooling Unit. (Improper model selection)	If the unit is properly installed and the compressor runs at 100% capacity (capacity setting can be checked in the monitor mode), select a model that provides larger cooling capacity.
			2) There is an obstacle near the air intake/exhaust port, resulting in cooling capacity deterioration.	Do not place any object that blocks ventilation at 500 mm or shorter distance from the air intake/exhaust port.
			3) The unit is running under capacity suppressing control, because the standard temperature (room temperature: 35°C, oil temperature: 35°C) has been exceeded.	If the standard temperature is exceeded, the cooling capacity becomes smaller than the nominal capacity, because the unit runs under capacity suppressing control. Make sure that the cooling capacity of the Oil Cooling Unit is larger than the main machine heating value throughout the operating temperature range.
			4) Temperature control is disabled because the unit is operated in Mode 9 (capacity direct designation mode).	Select an appropriate operation mode. (The capacity direct designation mode does not execute temperature feedback control.)
			5) The refrigerant gas has leaked.	If the exhaust air temperature is almost equal to the room temperature regardless of the compressor operation, it is possible that the refrigerant gas has leaked. Contact DAIKIN Contact Center.

*Alarm level 1: Compressor, pump and fan stop.
Alarm level 2: Only compressor stops.

Alarm code	Alarm level	Description	Cause	Corrective action
JE	1	Pump outlet oil temperature thermistor error	1) The pump outlet oil temperature thermistor is disconnected or short-circuited.	Check the wiring of the relevant thermistor.
			2) For the models without pump outlet oil temperature thermistor: Dummy connector is not connected.	Connect a dummy connector to CN8.
JH	2	Oil temperature thermistor error (Th2: Outlet oil temperature thermistor) (Th4: Inlet oil temperature thermistor)	1) The oil temperature thermistor required for control is disconnected or short-circuited.	Identify the thermistor that indicates the error in the monitor mode on the operation panel ("99.9" is displayed), and check the sensor wiring.
J3	2	Discharge pipe temperature thermistor error	1) The discharge pipe temperature thermistor is disconnected or short-circuited.	Check the wiring of the relevant thermistor.
J5	2	EV valve outlet temperature thermistor error	1) The EV valve outlet temperature thermistor is disconnected or short-circuited.	Check the wiring of the relevant thermistor.
J6	2	Condenser temperature thermistor error	1) The condenser temperature thermistor is disconnected or short-circuited.	Check the wiring of the relevant thermistor.
L0	2	Inverter/compressor error	1) The compressor or inverter has a fault.	Replace the control board or compressor.
LC	2	INV-temperature control CPU communication error	1) Communication failure between the temperature control microprocessor and the inverter microprocessor.	Replace the control board, or improve the power supply environment. (Take noise suppressing measures.)
P3	2	Electrical equipment box temperature thermistor error	1) The electrical equipment box temperature thermistor is disconnected or shortcircuited.	Check the wiring of the relevant thermistor.
P4	2	Radiator fin temperature thermistor error	1) The radiator fin temperature thermistor is disconnected or short-circuited.	Check the wiring of the relevant thermistor.
U0	2	Gas shortage	1) The refrigerant piping is damaged by excess vibration during transportation, resulting in refrigerant gas leak.	Repair the refrigerant pipe, and refill refrigerant.
U1	1	Power supply reverse-phase connection	1) The power supply is connected in reverse phase.	Exchange any phase of the power supply wiring.
			2) The L3 phase is open.	Make sure that the L3 phase is properly connected to the power supply terminal block.
			3) The fuse in the control board has blown.	Contact DAIKIN Contact Center.
U2	2	Momentary power failure or voltage drop	1) The power supply voltage is lower than approx. 170 V.	Make sure that the power supply voltage conforms to the rating. Check for instantaneous voltage drop at startup of peripheral equipment.
U9	2	Other system communication error (Slave communication error)	1) An error occurred in communication with a slave.	Make sure that the slave communication line is properly connected. (This error occurs only when the slave does not make response in master-slave communication.)
UH	2	System failure (EEPROM error)	1) The parameter stored in the control board is invalid.	Replace the control board.
UJ	1 or 2	Optional protection device is activated. (OP2)	1) The optionally-connected protection device (or factory-connected device, if it is incorporated in the unit) has been activated.	Check the condition detected with the relevant protection device.
1E	–	Temperature range warning 1	1) The monitor temperature has exceeded the preset temperature. (It does not mean a fault of the Oil Cooling Unit.)	Check the preset warning condition.
2E	–	Temperature range warning 2		
3E	–	Temperature range warning 3		
4E	–	Temperature range warning 4		
5E	–	Temperature range warning 5		



DAIKIN INDUSTRIES, LTD.

Oil Hydraulic Equipment

Osaka Office

DAIKIN Esaka Building, Tarumi-cho 3-21-3,

Suita, Osaka, Japan 564-0062

TEL : 81-6-6378-8764

FAX : 81-6-6378-8738

E-mail Address: hyd_eco@daikin.co.jp

Home Page: <http://www.daikin.co.jp>